

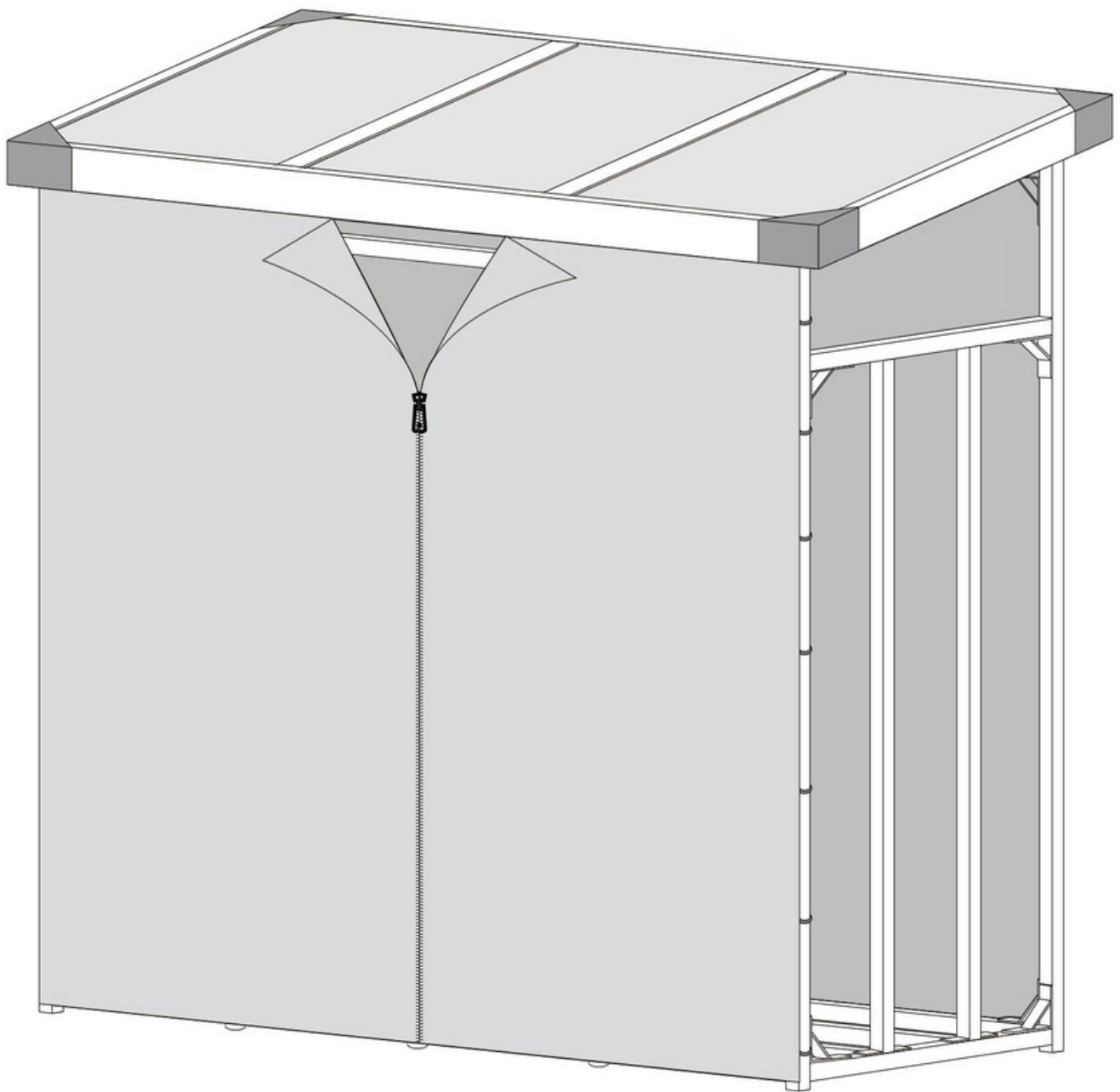











# Montageanleitung

Kaminholzregal M H4H378.1













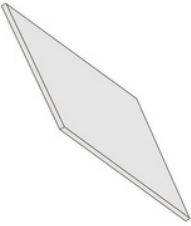

# Montageanleitung

## Kaminholzregal M H4H378.1

Schrauben und Zubehör							
Nummer	Illustration	Maß	Stückzahl	Nummer	Illustration	Maß	Stückzahl
<b>A</b>		M8 × 40mm	× 16	<b>G</b>		Fuß	× 12
<b>B</b>		M8 × 35mm	× 76	<b>H</b>		M6 Innensechskant-Schlüssel	× 1
<b>C</b>		90° Verbindung	× 16	<b>I</b>		M8 Innensechskant-Schlüssel	× 1
<b>D</b>		Eckenverbindungsstück	× 4	<b>J</b>		M6 Schraubenschlüssel	× 1
<b>E</b>		M8 × 16mm	× 8	<b>K</b>		M8 Schraubenschlüssel	× 1
<b>F</b>		M6 × 45mm	× 4	<b>L</b>		Mutter	× 72

Stückliste								
Nummer	Stückart	Anzahl	Nummer	Stückart	Anzahl	Nummer	Stückart	Anzahl
<b>1</b>		× 2	<b>6</b>		× 2	<b>11</b>		× 2
<b>2</b>		× 2	<b>7</b>		× 2	<b>12</b>		× 2
<b>3</b>		× 4	<b>8</b>		× 2	<b>13</b>		× 1
<b>4</b>		× 2	<b>9</b>		× 2	<b>14</b>		× 1
<b>5</b>		× 2	<b>10</b>		× 2			

# Montageanleitung

## Kaminholzregal M H4H378.1

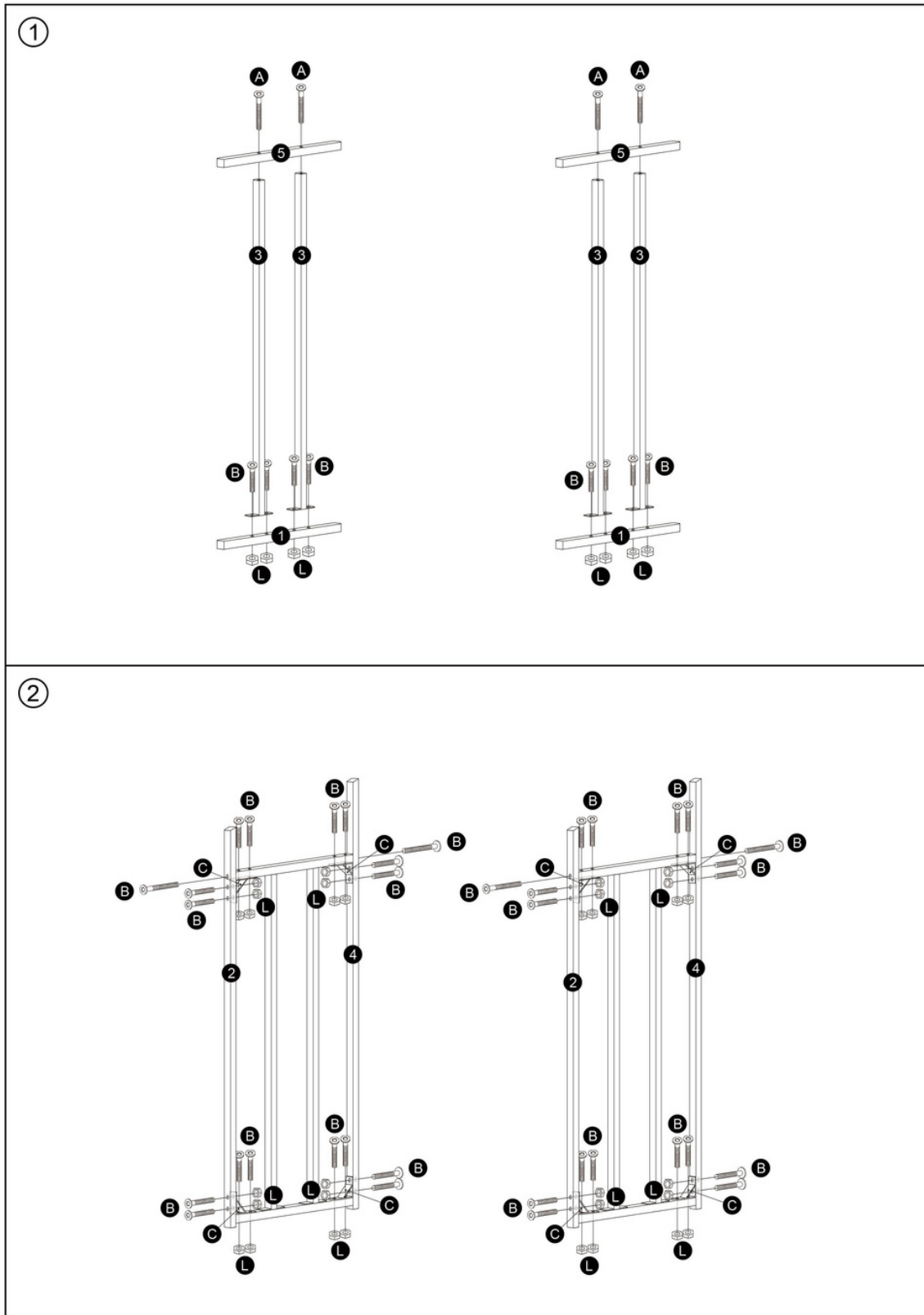

# Montageanleitung

## Kaminholzregal M H4H378.1

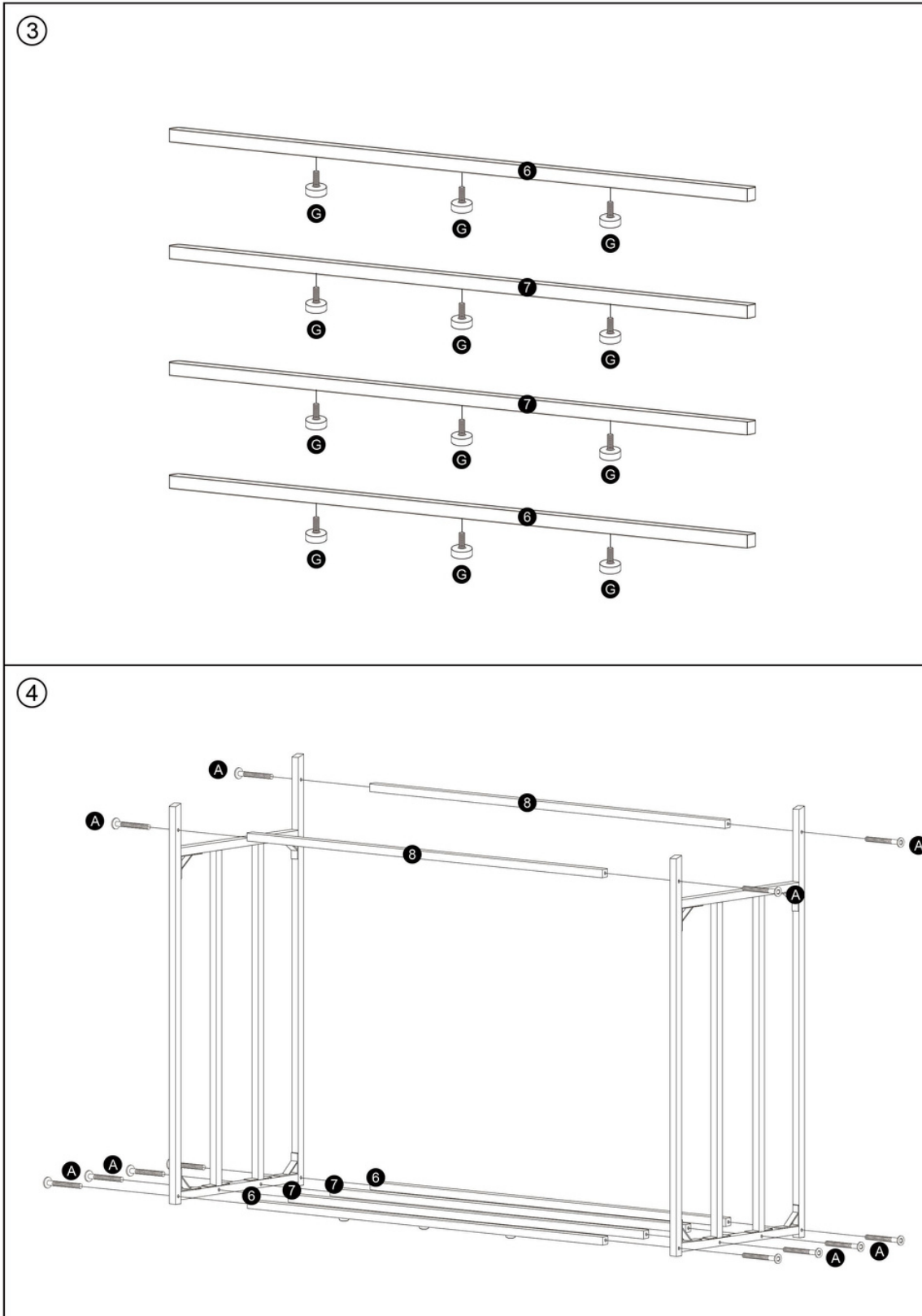



# Montageanleitung

## Kaminholzregal M H4H378.1

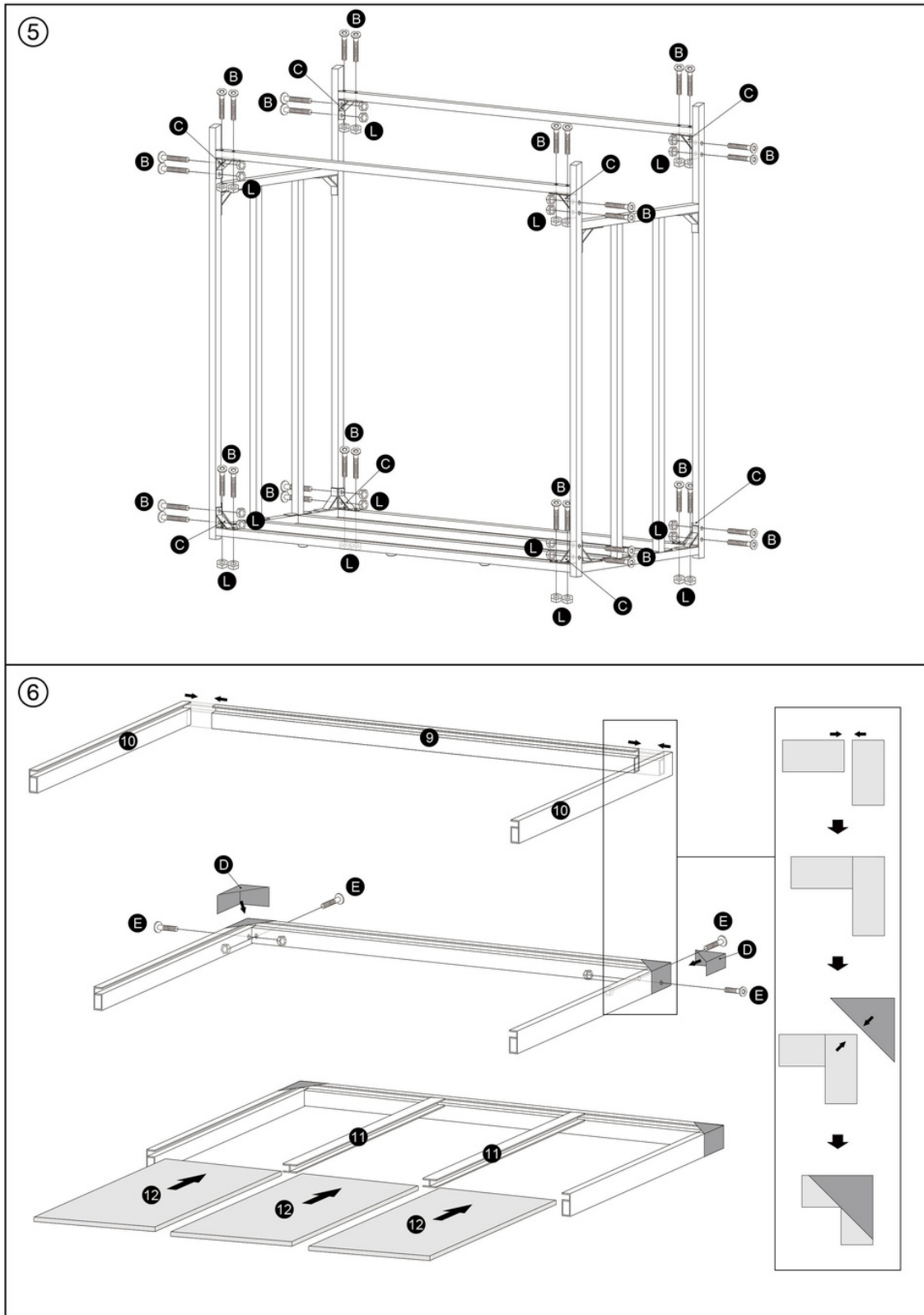

# Montageanleitung

## Kaminholzregal M H4H378.1

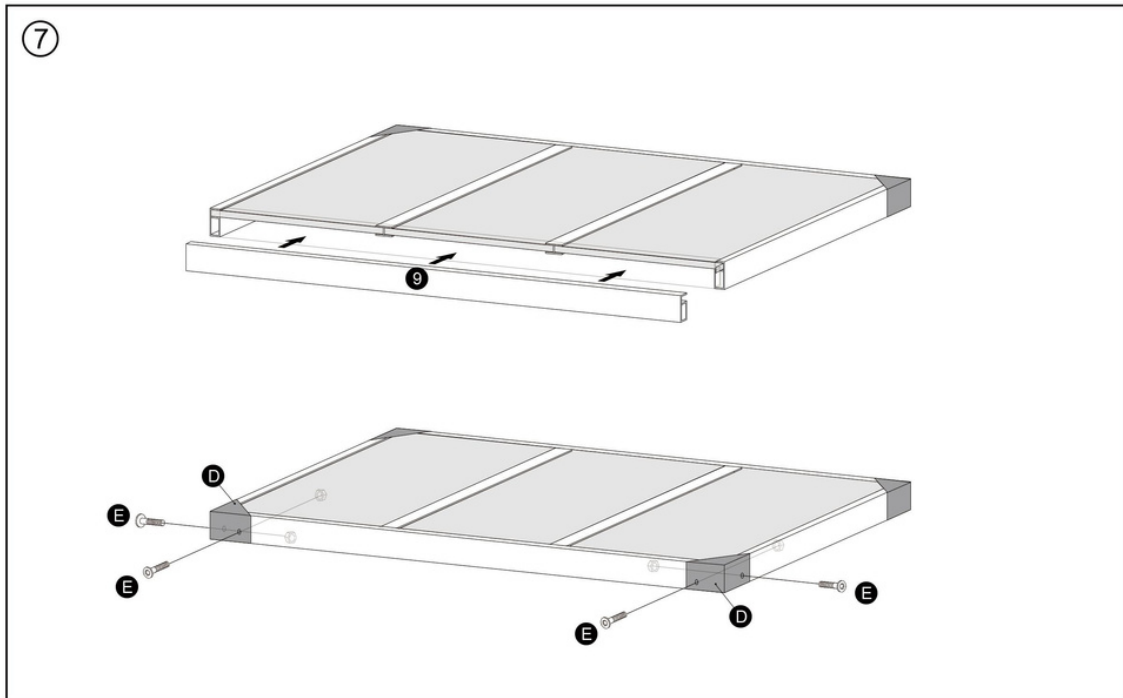

# Montageanleitung

Kaminholzregal M H4H378.1

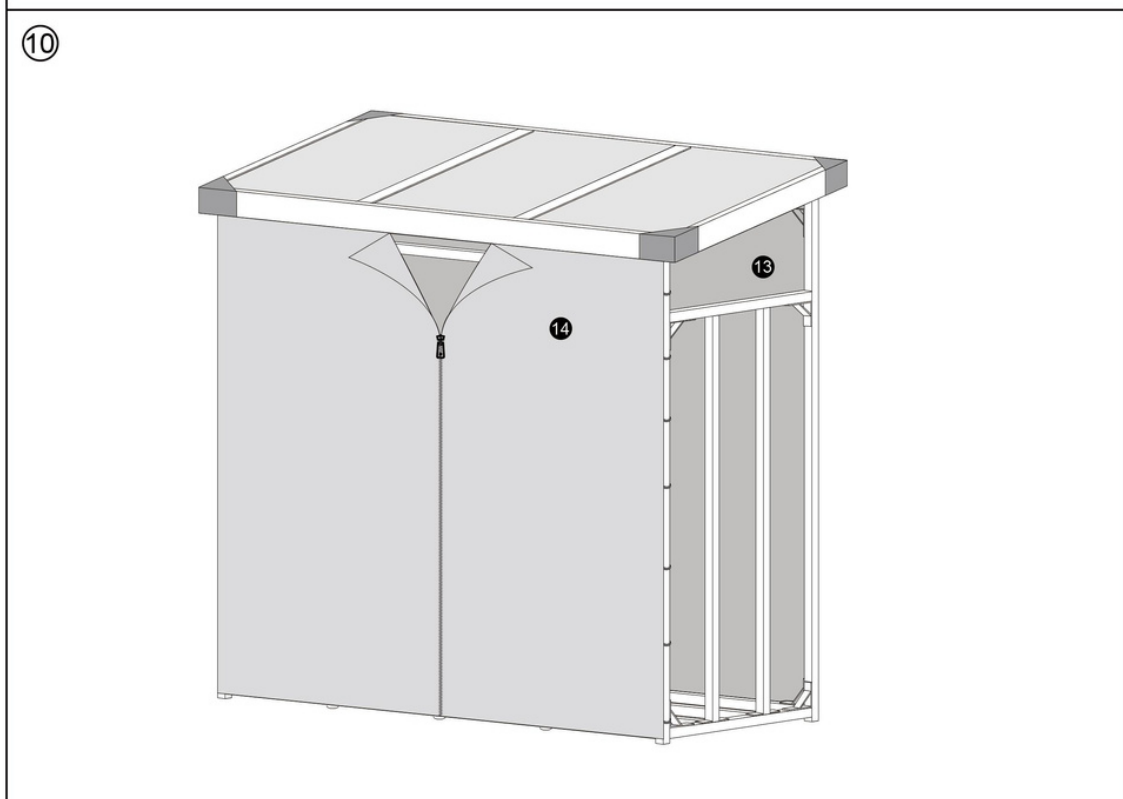
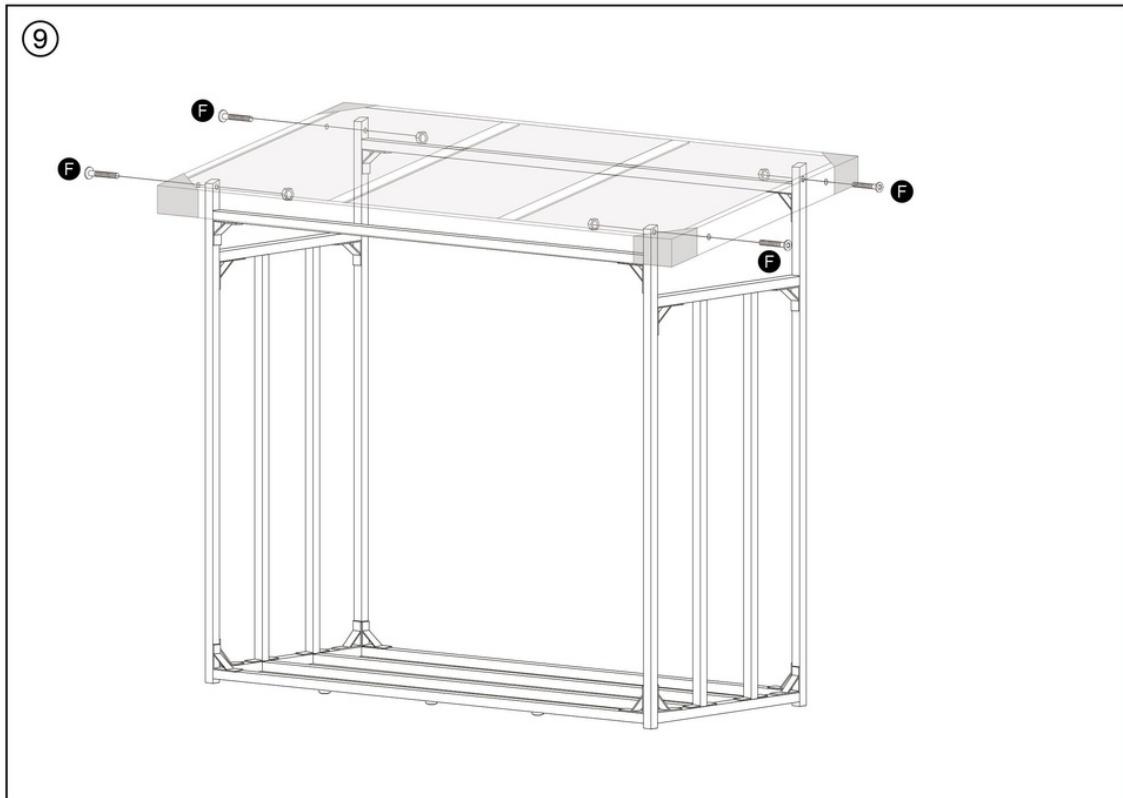





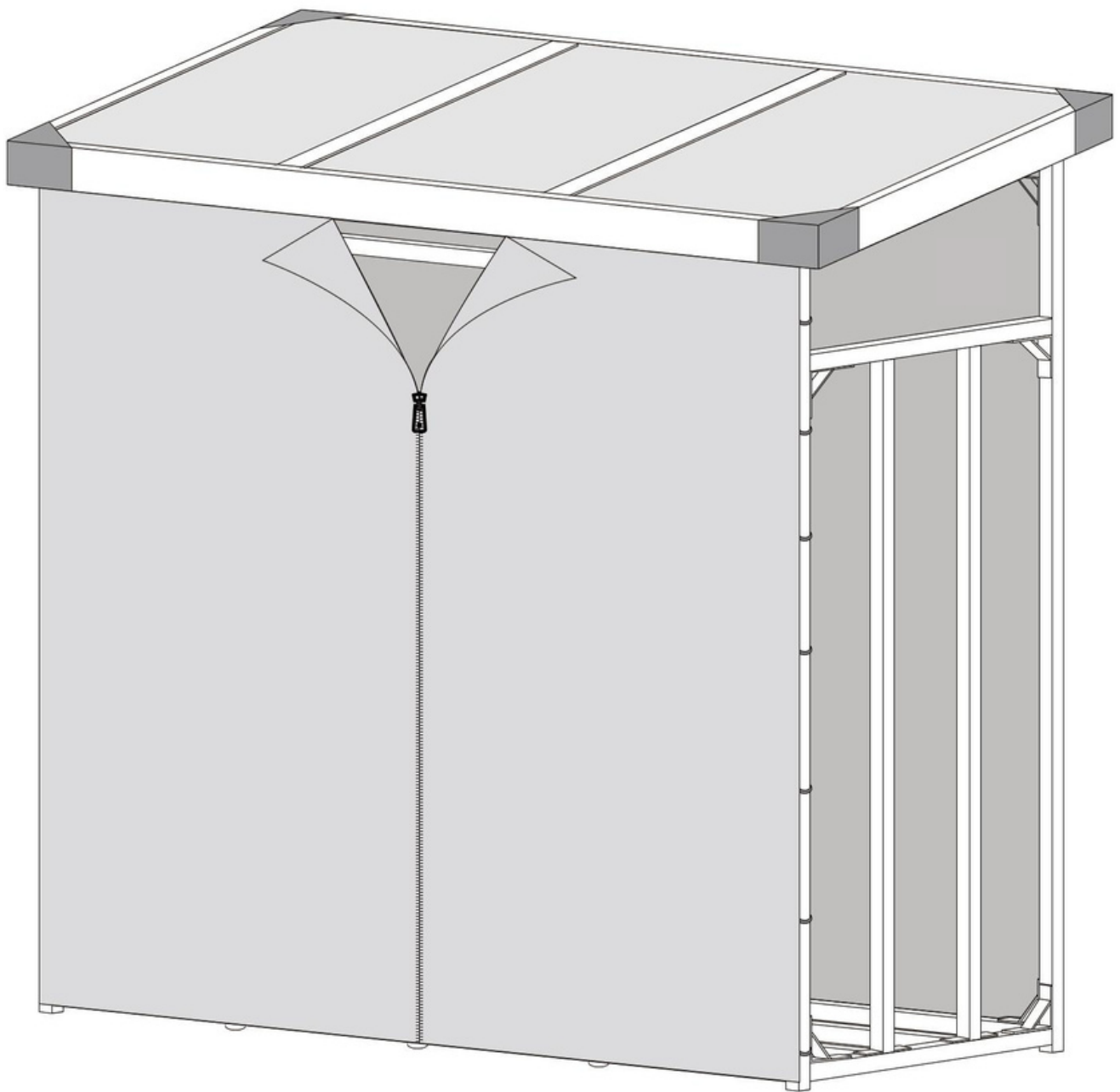







# Assembly Instruction

Firewood Rack M H4H378.1













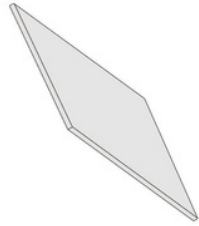

# Assembly Instruction

## Firewood Rack M H4H378.1

Screws and Accessories							
Number	Illustration	Dimension	Piece	Number	Illustration	Dimension	Piece
<b>A</b>		M8 × 40mm	× 16	<b>G</b>		Foot pad	× 12
<b>B</b>		M8 × 35mm	× 76	<b>H</b>		M6-Allen wrench	× 1
<b>C</b>		90° connector	× 16	<b>I</b>		M8-Allen wrench	× 1
<b>D</b>		Corner fixer	× 4	<b>J</b>		M6-Wrench	× 1
<b>E</b>		M8 × 16mm	× 8	<b>K</b>		M8-Wrench	× 1
<b>F</b>		M6 × 45mm	× 4	<b>L</b>		Screw nut	× 72

Parts List								
Number	Part art	Piece	Number	Part art	Piece	Number	Part art	Piece
<b>1</b>		× 2	<b>6</b>		× 2	<b>11</b>		× 2
<b>2</b>		× 2	<b>7</b>		× 2	<b>12</b>		× 2
<b>3</b>		× 4	<b>8</b>		× 2	<b>13</b>		× 1
<b>4</b>		× 2	<b>9</b>		× 2	<b>14</b>		× 1
<b>5</b>		× 2	<b>10</b>		× 2			

# Assembly Instruction

Firewood Rack M H4H378.1

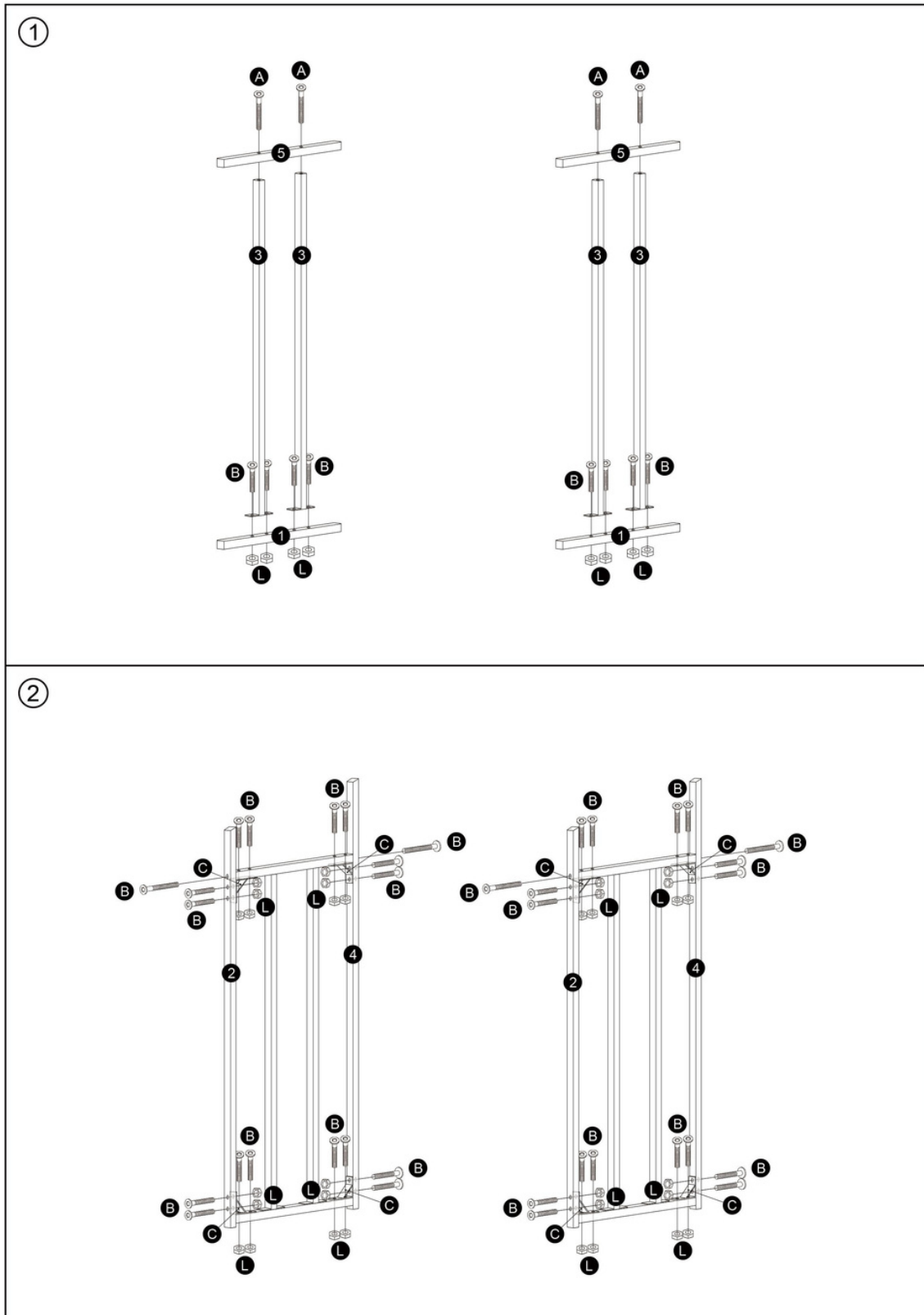

# Assembly Instruction

Firewood Rack M H4H378.1

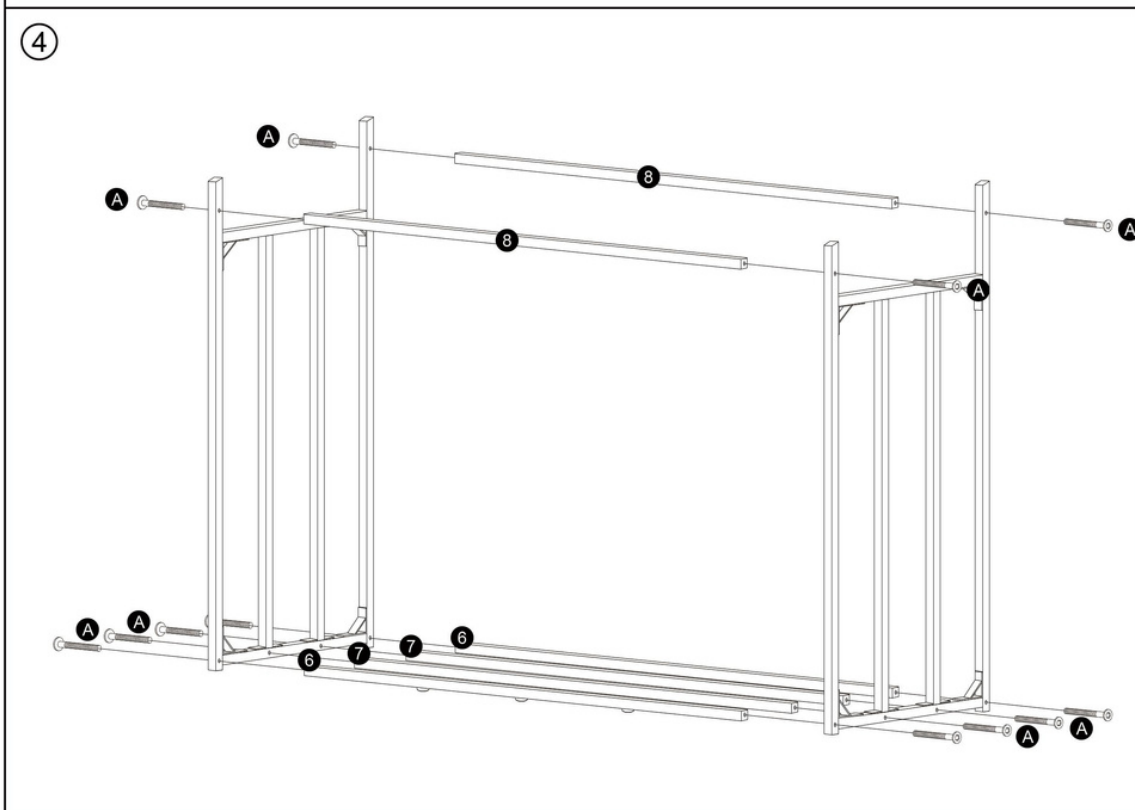
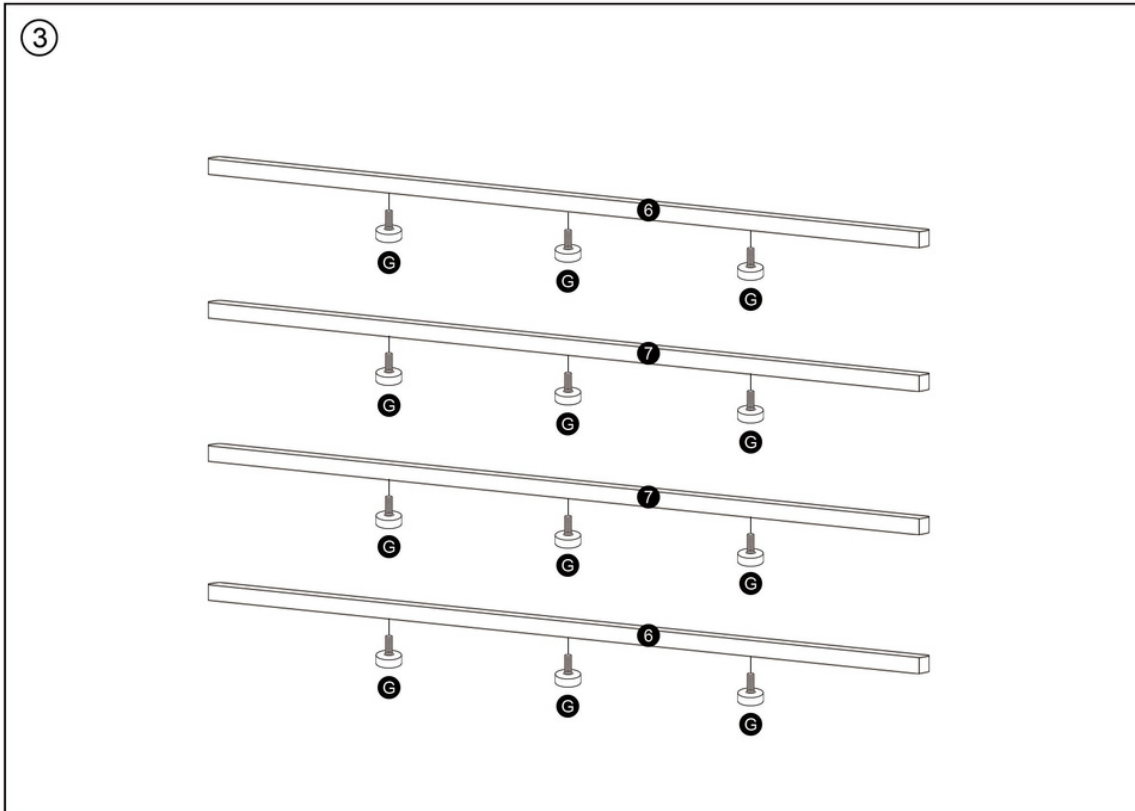

# Assembly Instruction

Firewood Rack M H4H378.1

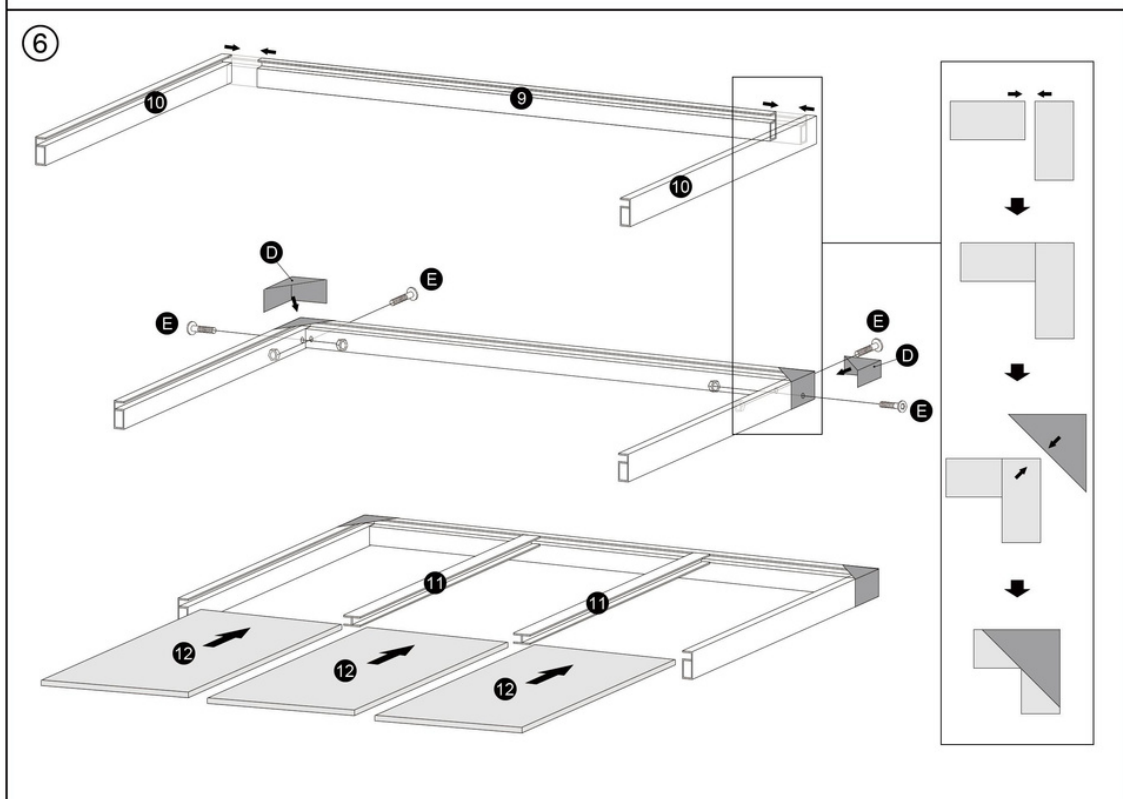
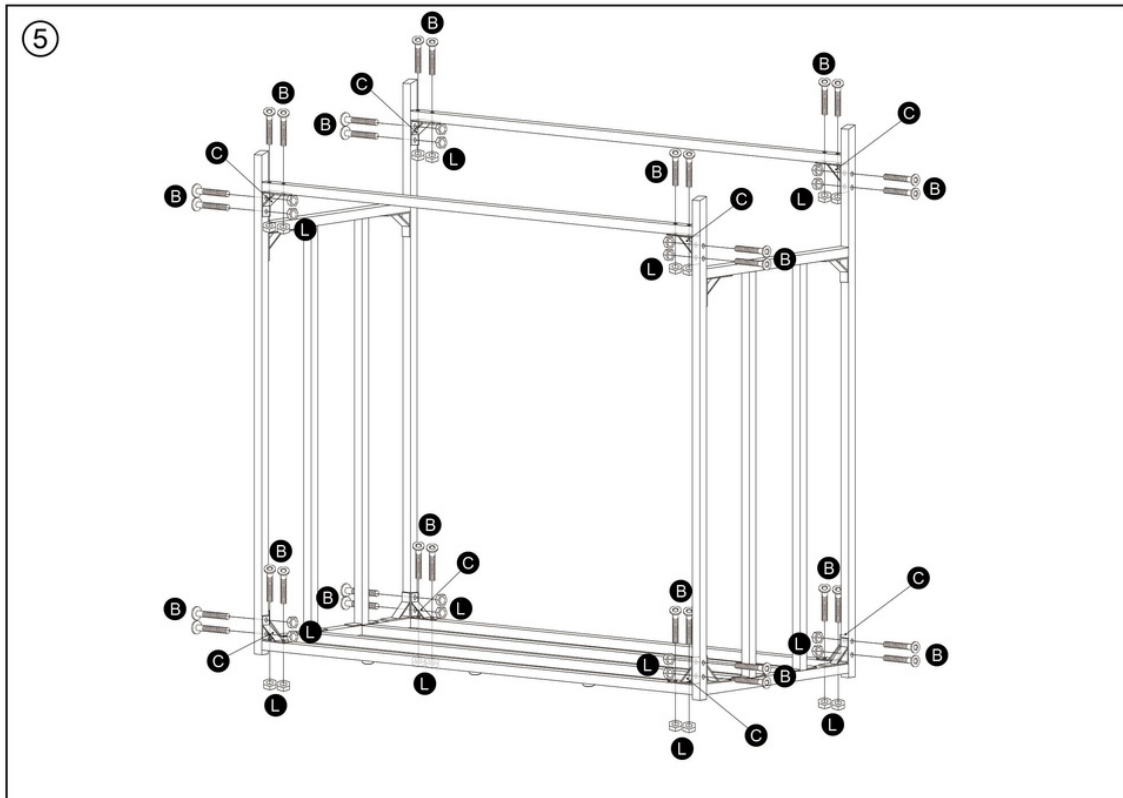



# Assembly Instruction

Firewood Rack M H4H378.1

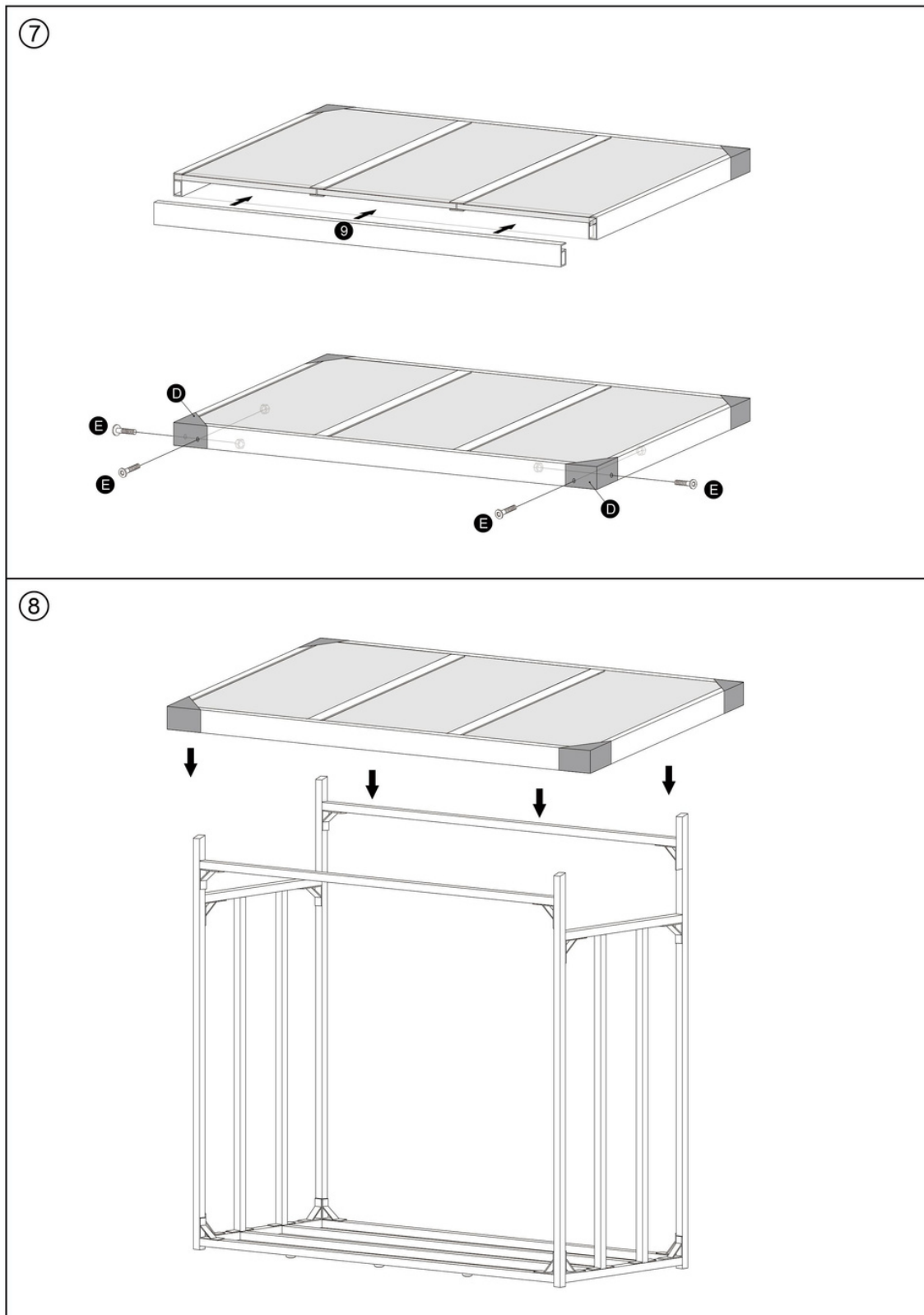

# Assembly Instruction

Firewood Rack M H4H378.1

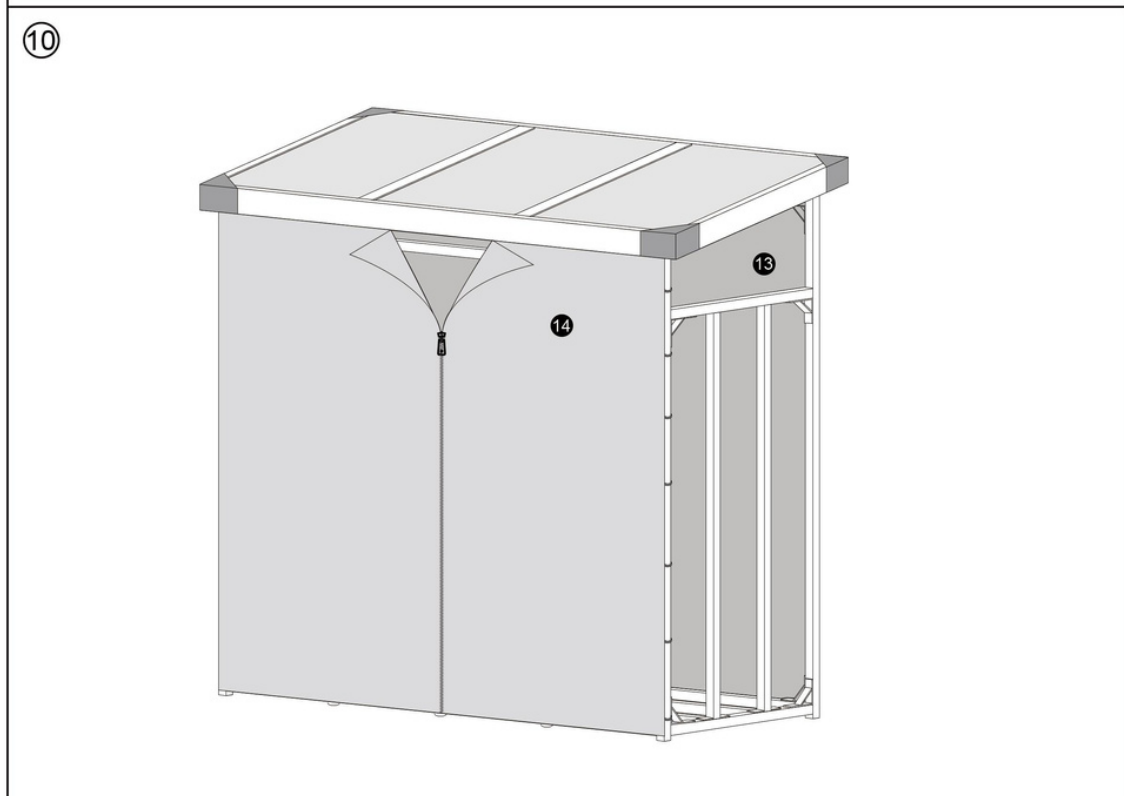
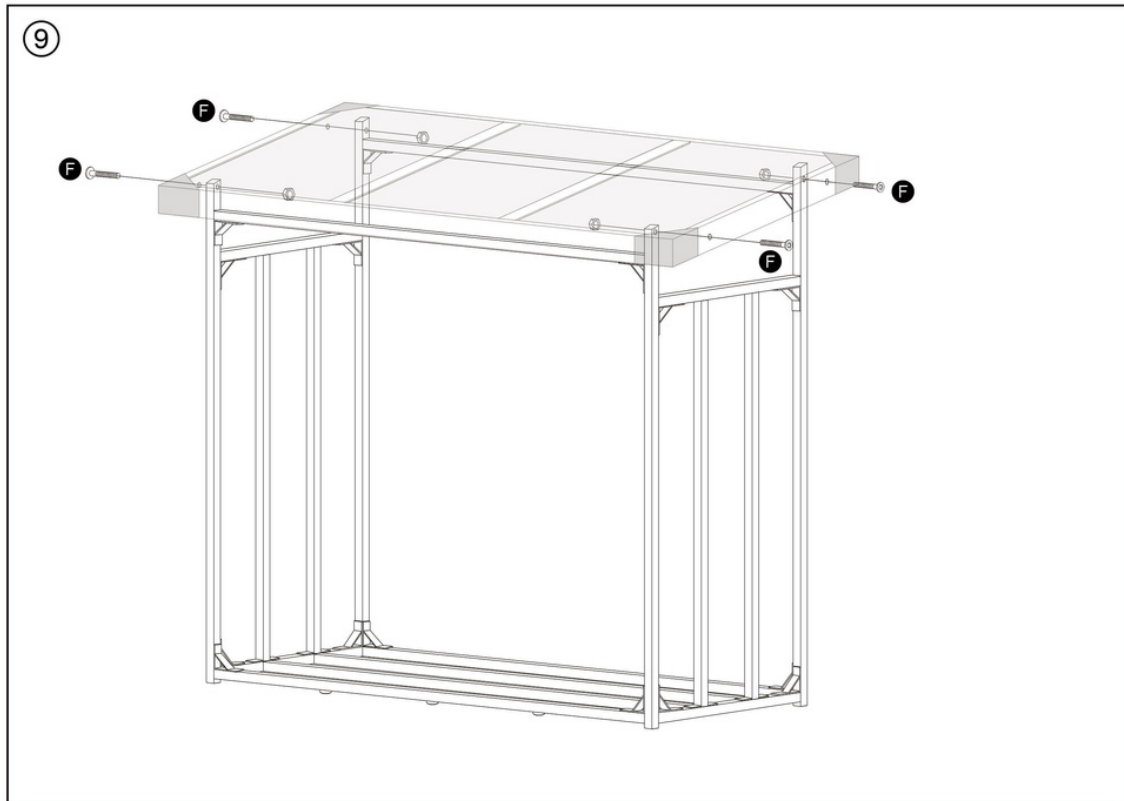





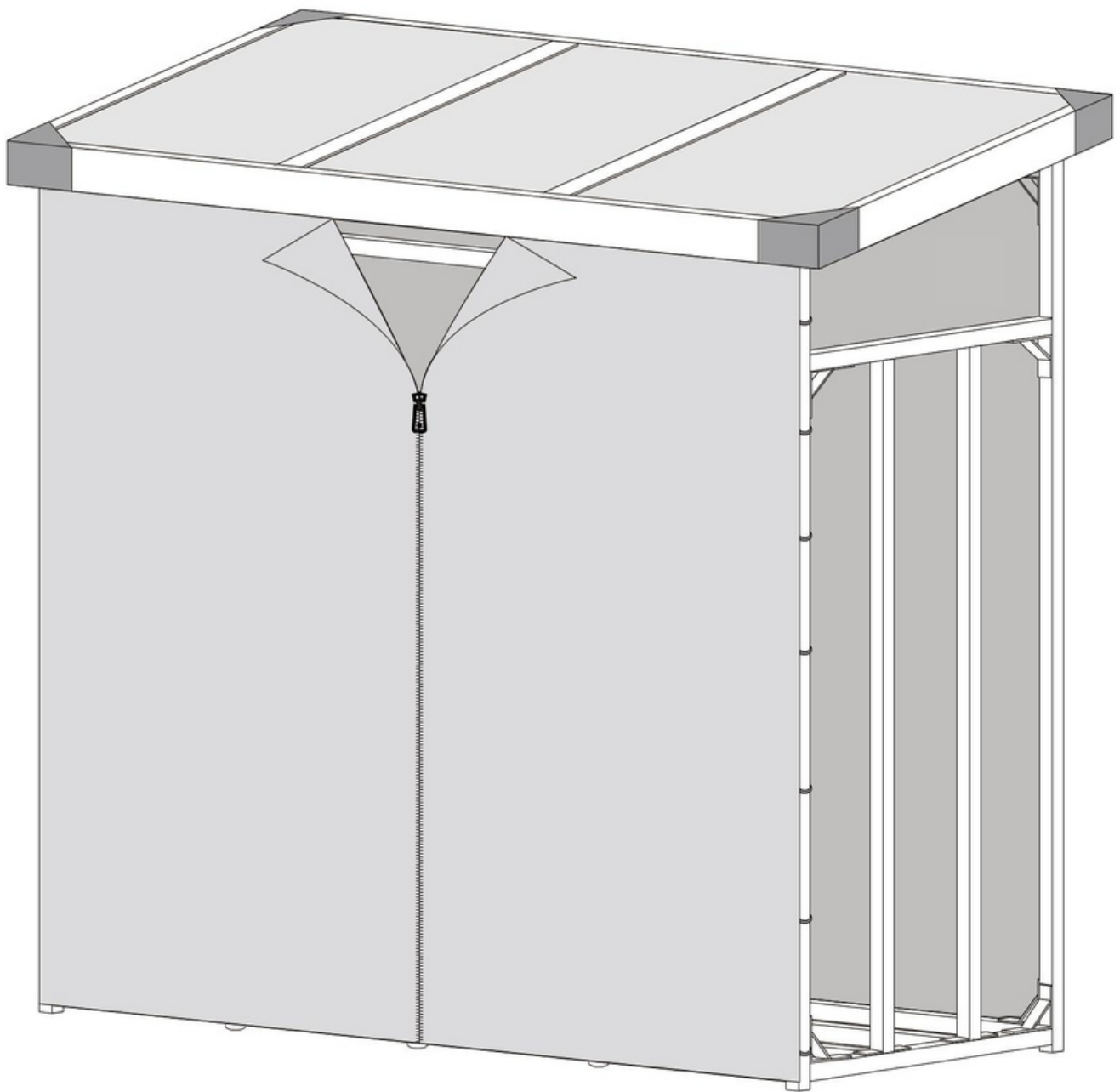







# Montageanleitung

Kaminholzregal L H4H378.2













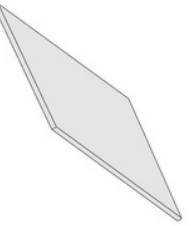

# Montageanleitung

## Kaminholzregal L H4H378.2

Schrauben und Zubehör							
Nummer	Illustration	Maß	Stückzahl	Nummer	Illustration	Maß	Stückzahl
<b>A</b>		M8 × 40mm	× 16	<b>G</b>		Fuß	× 8
<b>B</b>		M8 × 35mm	× 76	<b>H</b>		M6 Innensechskant-Schlüssel	× 1
<b>C</b>		90° Verbindung	× 16	<b>I</b>		M8 Innensechskant-Schlüssel	× 1
<b>D</b>		Eckenverbindungsstück	× 4	<b>J</b>		M6 Schraubenschlüssel	× 1
<b>E</b>		M8 × 16mm	× 8	<b>K</b>		M8 Schraubenschlüssel	× 1
<b>F</b>		M6 × 45mm	× 4	<b>L</b>		Mutter	× 72

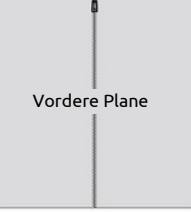
Stückliste								
Nummer	Stückart	Anzahl	Nummer	Stückart	Anzahl	Nummer	Stückart	Anzahl
<b>1</b>		× 2	<b>6</b>		× 2	<b>11</b>		× 2
<b>2</b>		× 2	<b>7</b>		× 2	<b>12</b>		× 2
<b>3</b>		× 4	<b>8</b>		× 2	<b>13</b>		× 1
<b>4</b>		× 2	<b>9</b>		× 2	<b>14</b>		× 1
<b>5</b>		× 2	<b>10</b>		× 2			

# Montageanleitung

## Kaminholzregal L H4H378.2

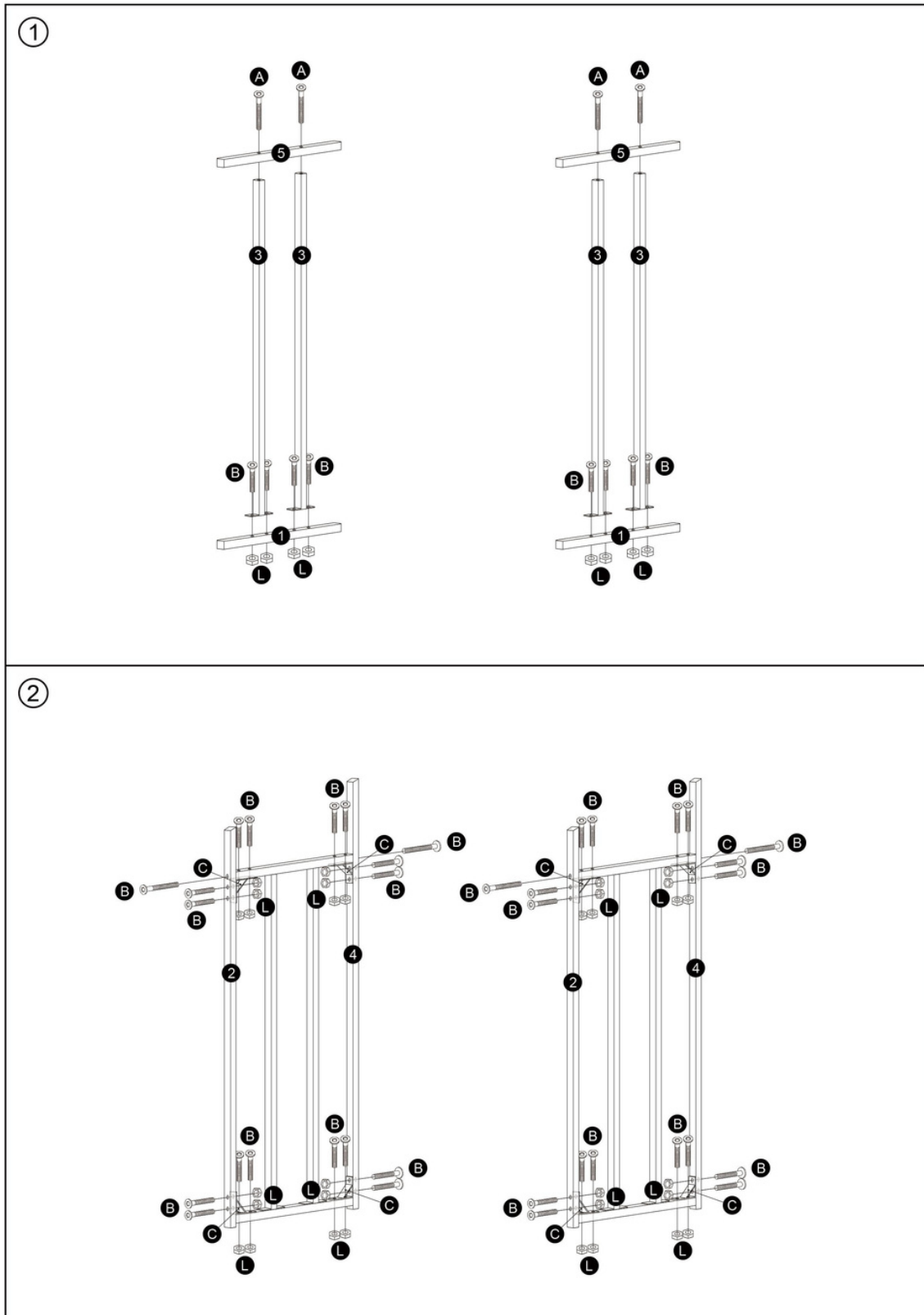

# Montageanleitung

## Kaminholzregal L H4H378.2

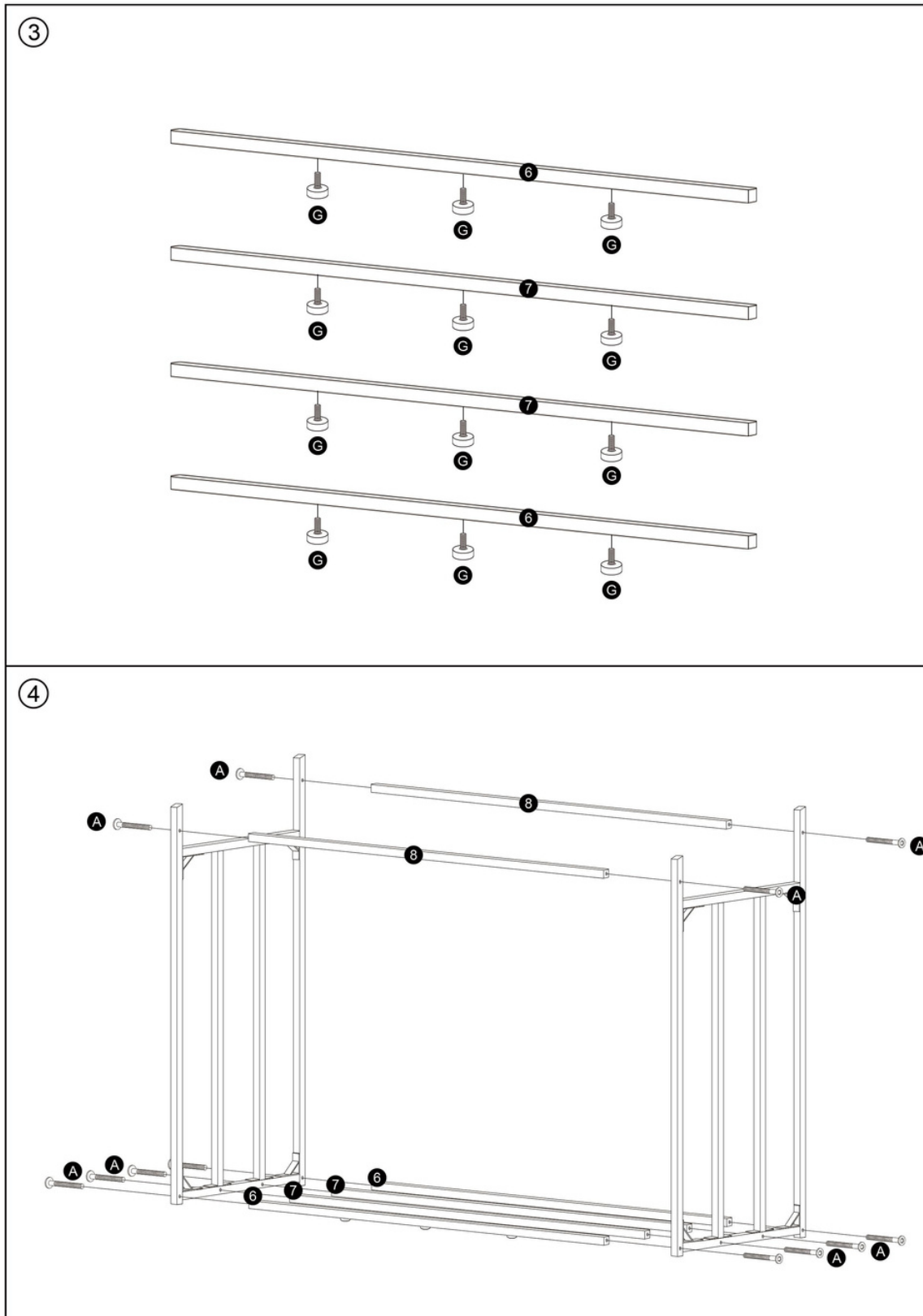

# Montageanleitung

Kaminholzregal L H4H378.2

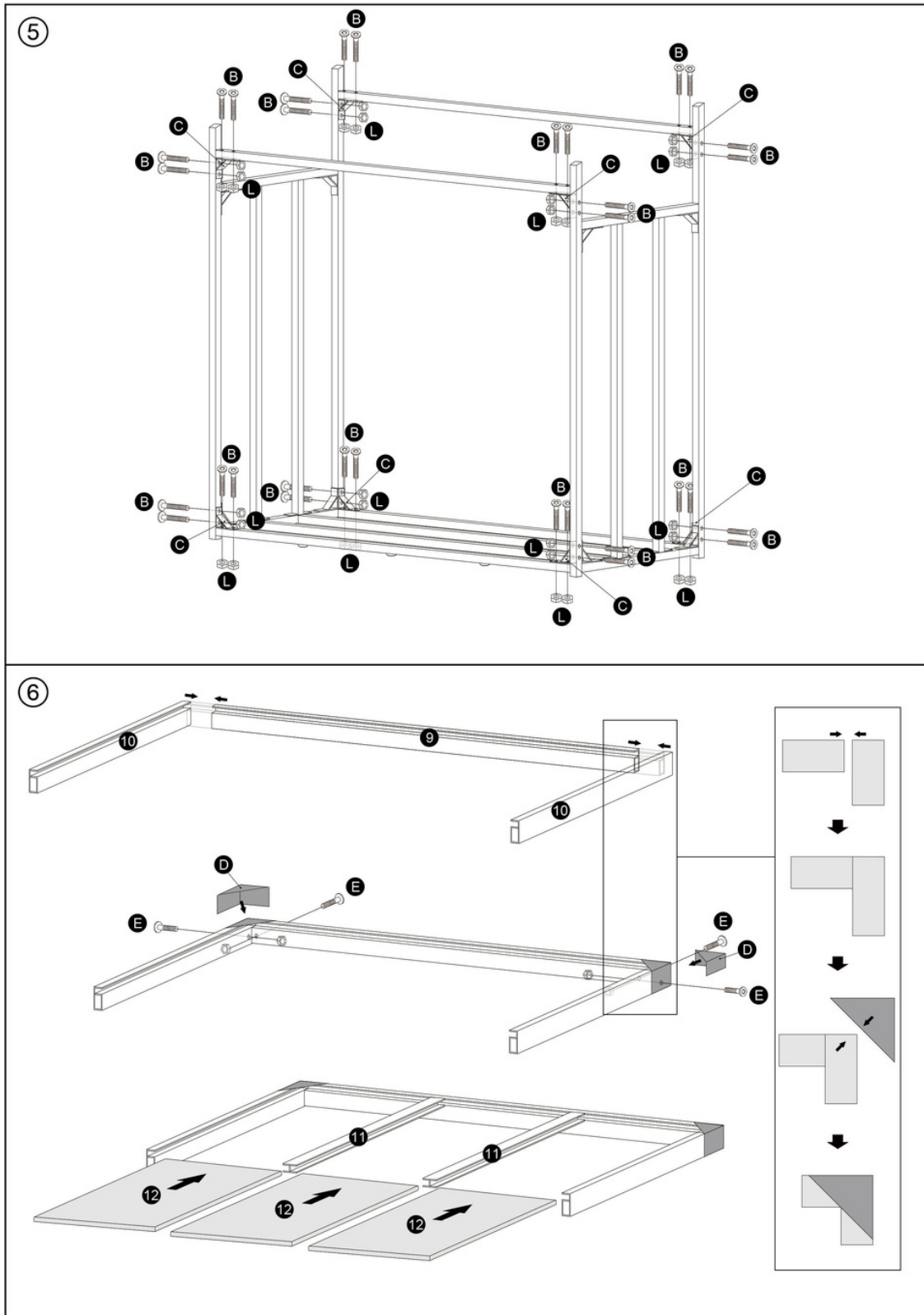

# Montageanleitung

## Kaminholzregal L H4H378.2

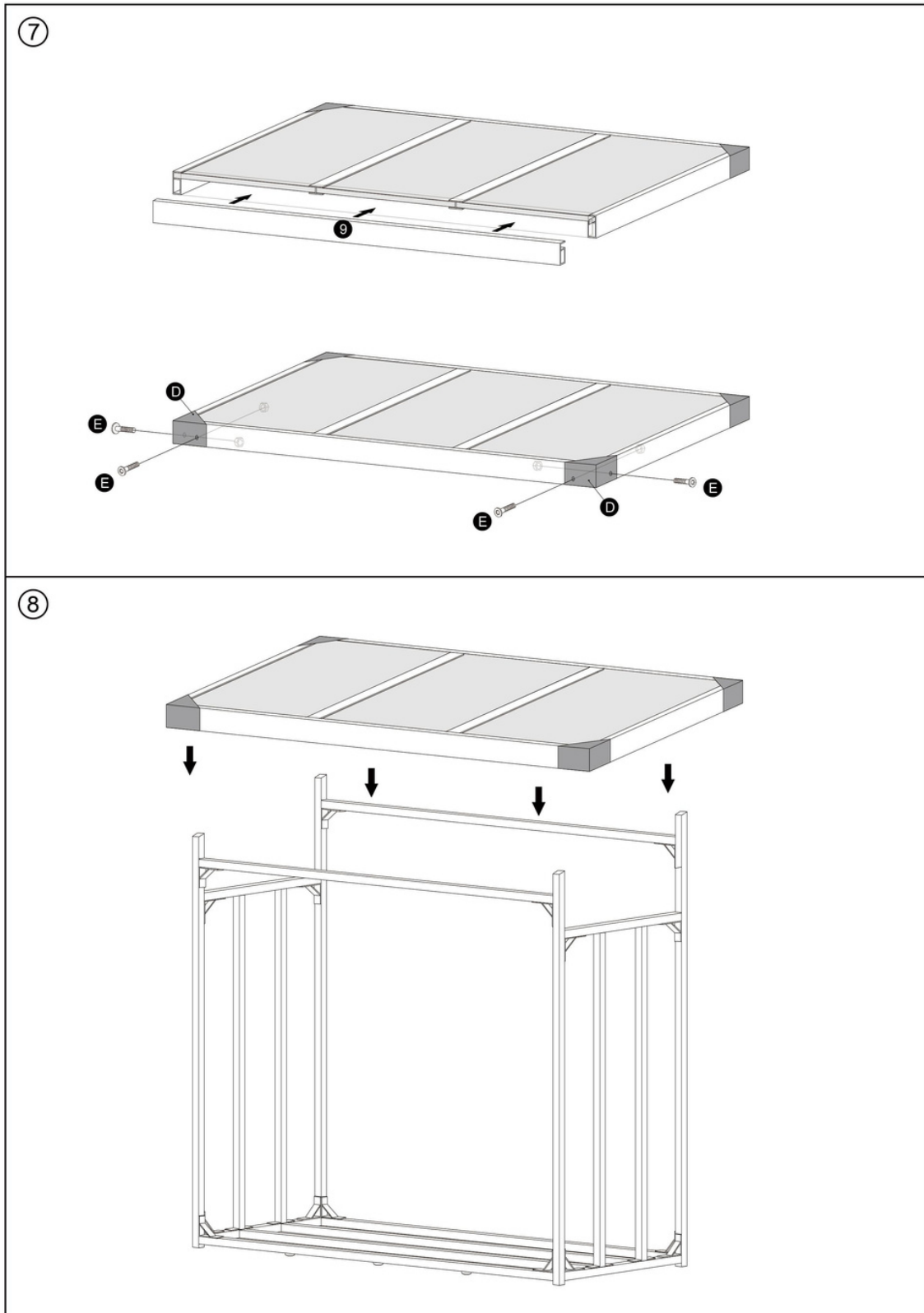



# Montageanleitung

Kaminholzregal L H4H378.2

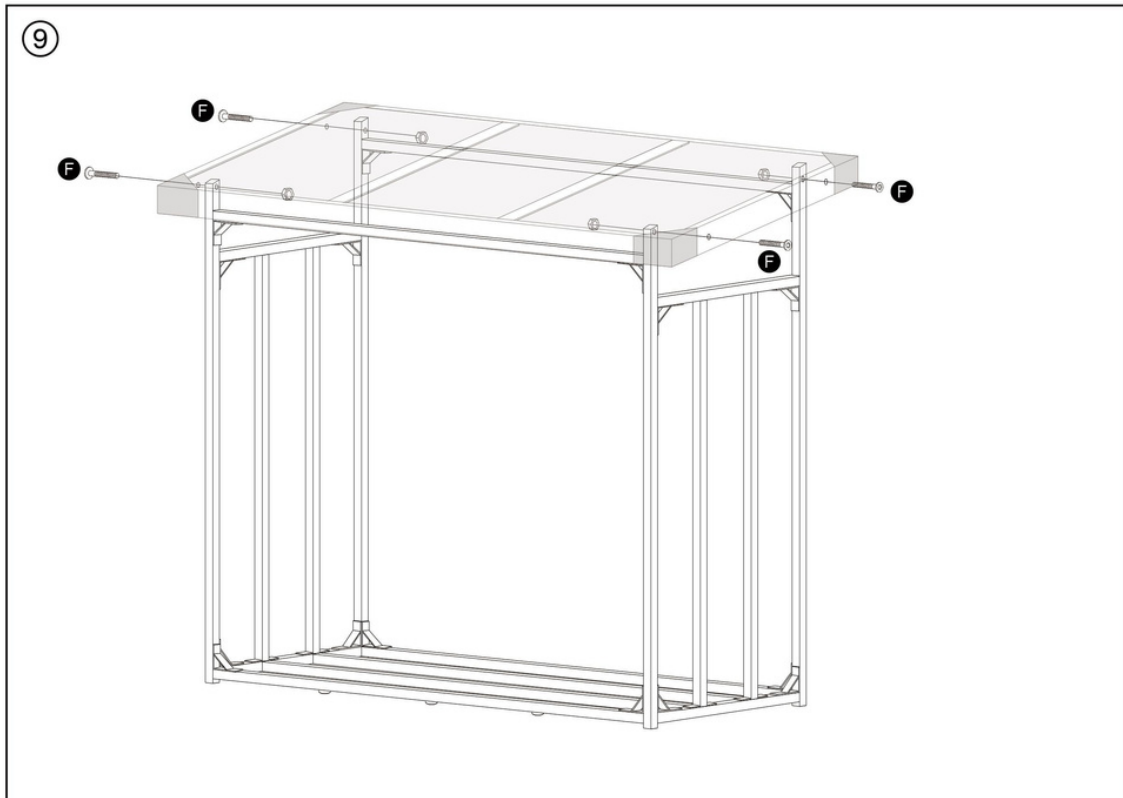





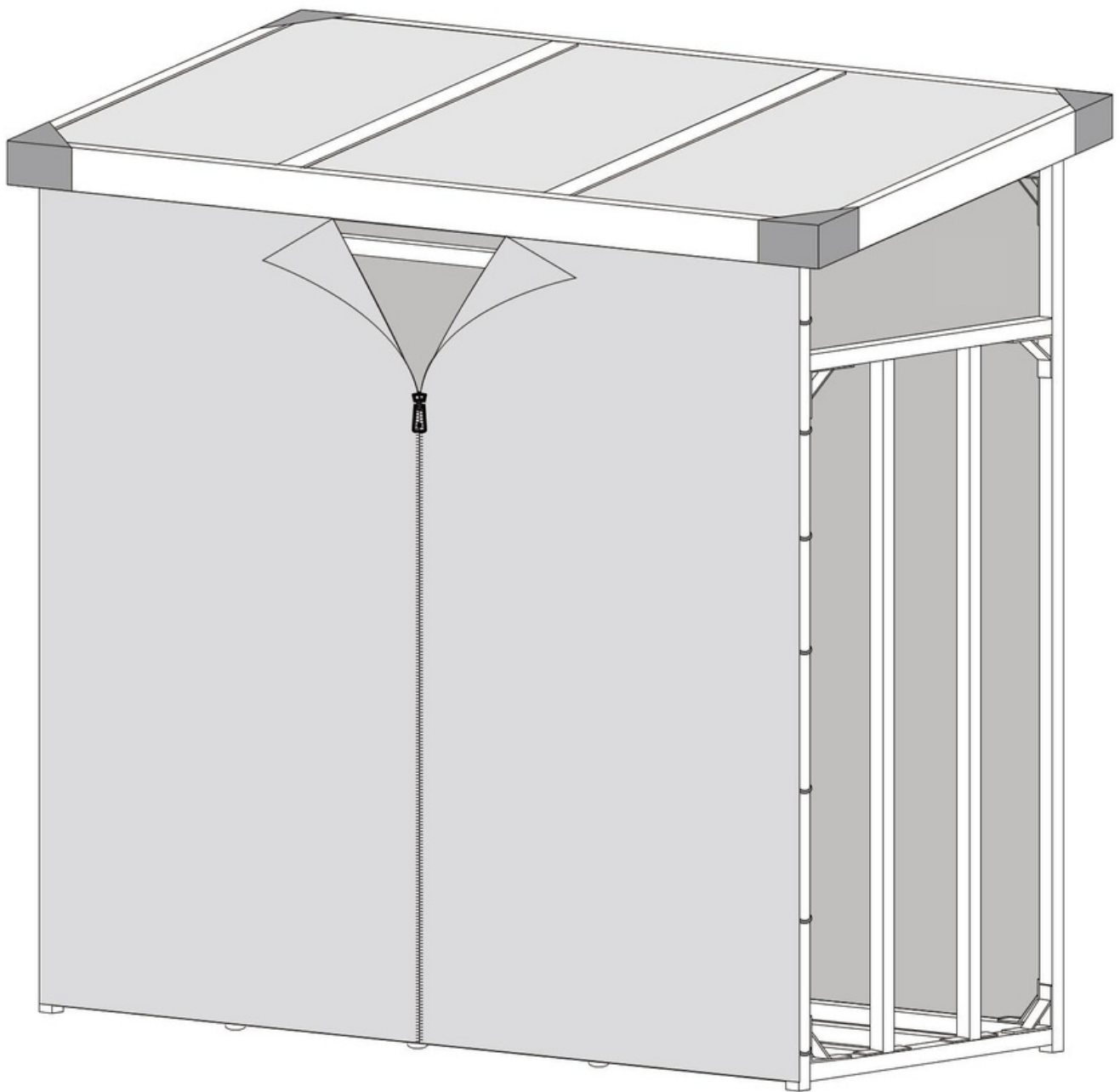







# Assembly Instruction

Firewood Rack L H4H378.2













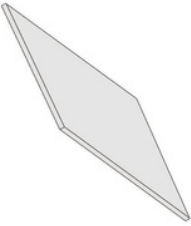

# Assembly Instruction

## Firewood Rack L H4H378.2

Screws and Accessories							
Number	Illustration	Dimension	Piece	Number	Illustration	Dimension	Piece
<b>A</b>		M8 × 40mm	× 16	<b>G</b>		Foot pad	× 8
<b>B</b>		M8 × 35mm	× 76	<b>H</b>		M6-Allen wrench	× 1
<b>C</b>		90° connector	× 16	<b>I</b>		M8-Allen wrench	× 1
<b>D</b>		Corner fixer	× 4	<b>J</b>		M6-Wrench	× 1
<b>E</b>		M8 × 16mm	× 8	<b>K</b>		M8-Wrench	× 1
<b>F</b>		M6 × 45mm	× 4	<b>L</b>		Screw nut	× 72

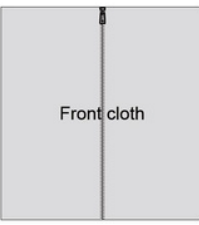
Parts List								
Number	Part art	Piece	Number	Part art	Piece	Number	Part art	Piece
<b>1</b>		× 2	<b>6</b>		× 2	<b>11</b>		× 2
<b>2</b>		× 2	<b>7</b>		× 2	<b>12</b>		× 2
<b>3</b>		× 4	<b>8</b>		× 2	<b>13</b>		× 1
<b>4</b>		× 2	<b>9</b>		× 2	<b>14</b>		× 1
<b>5</b>		× 2	<b>10</b>		× 2			

# Assembly Instruction

## Firewood Rack L H4H378.2

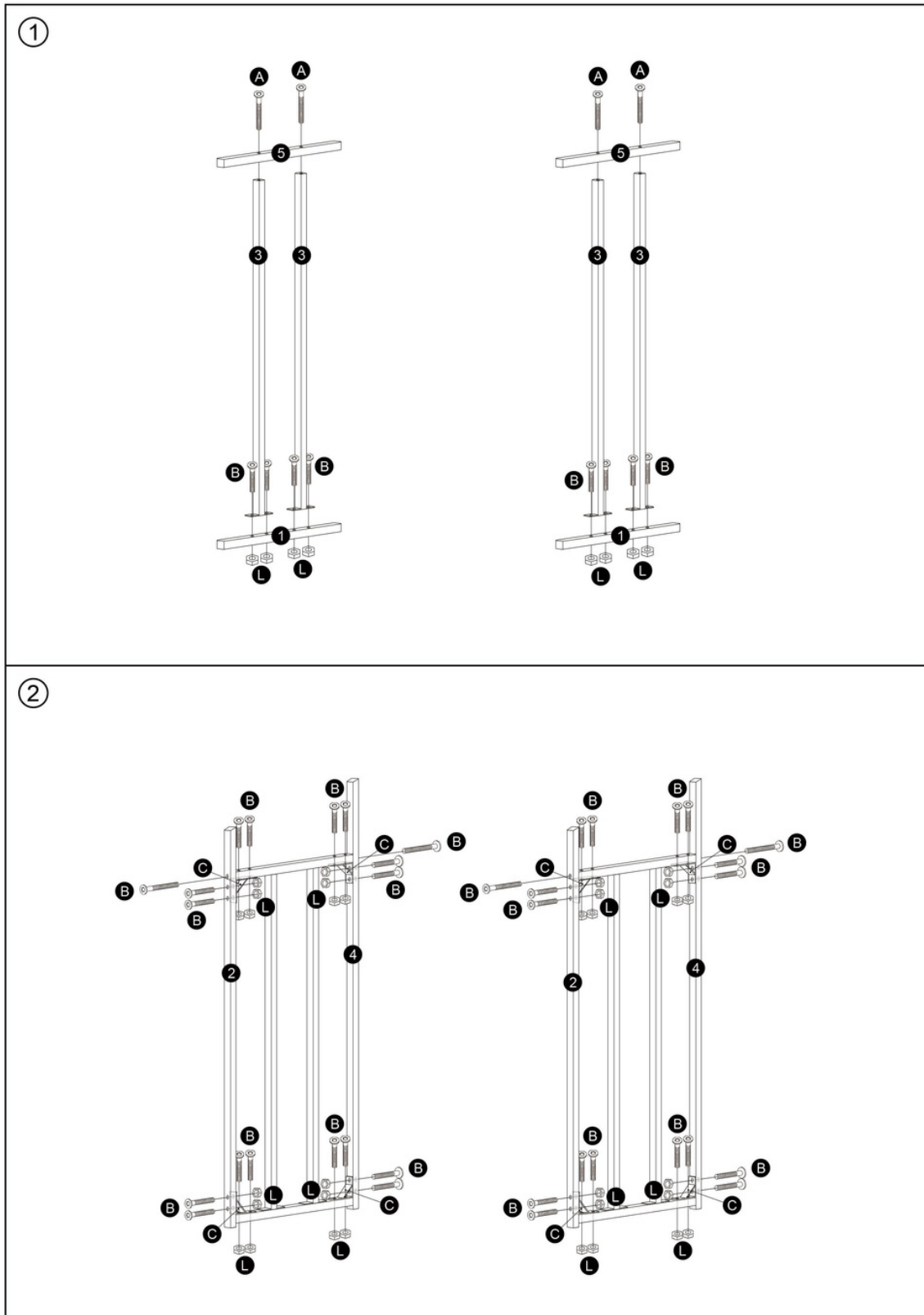

# Assembly Instruction

## Firewood Rack L H4H378.2

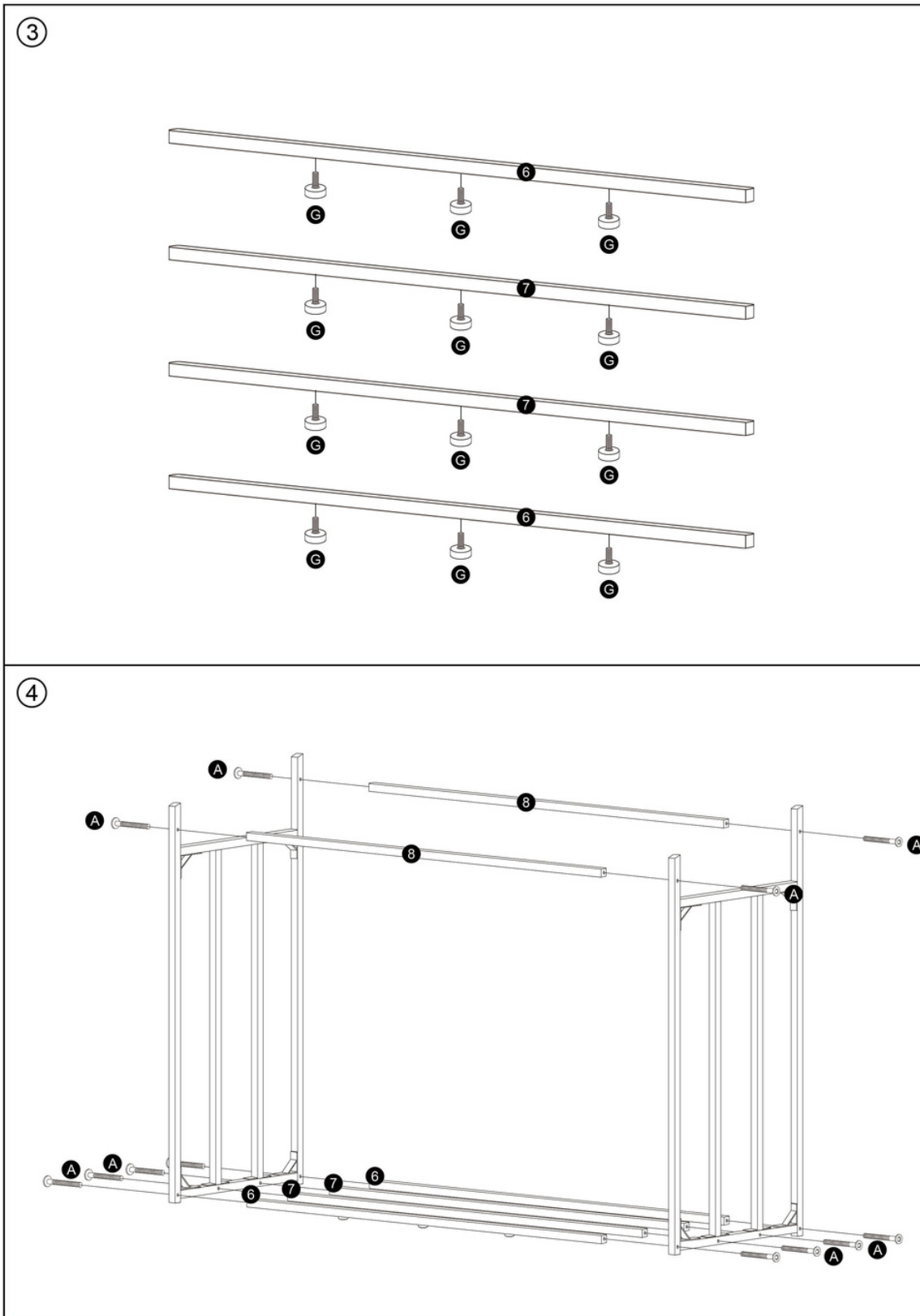

# Assembly Instruction

## Firewood Rack L H4H378.2

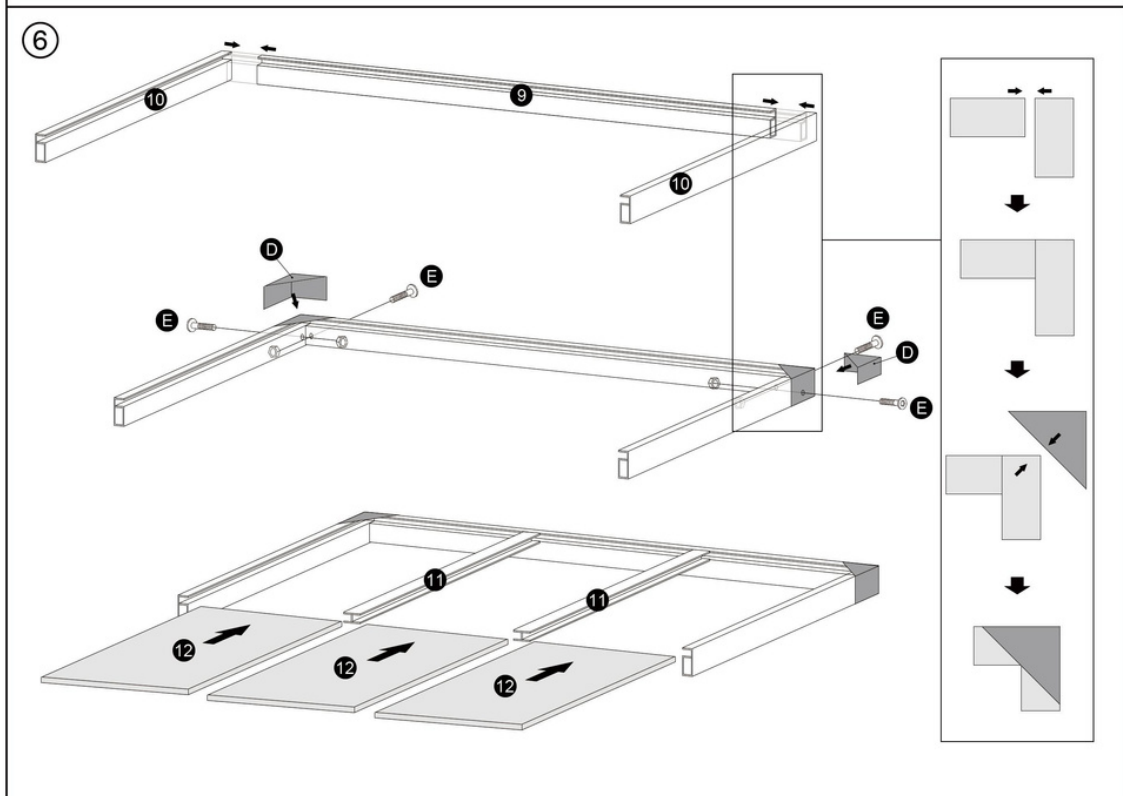
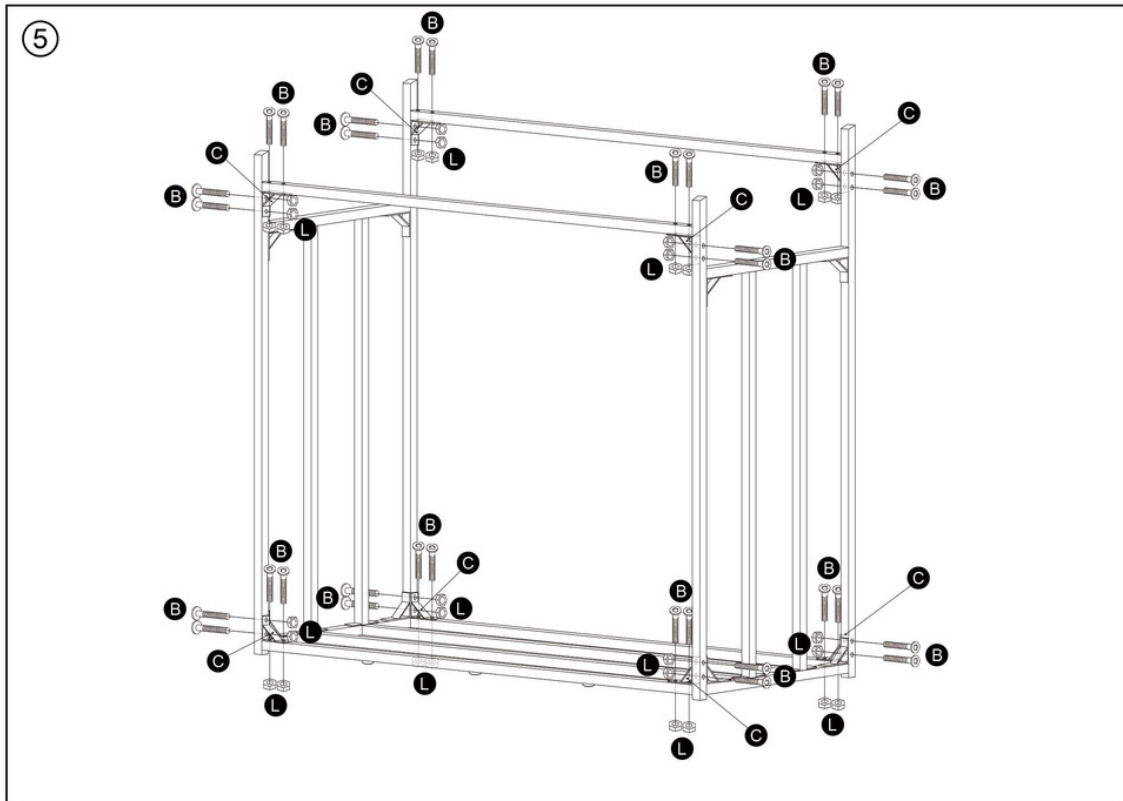

# Assembly Instruction

## Firewood Rack L H4H378.2

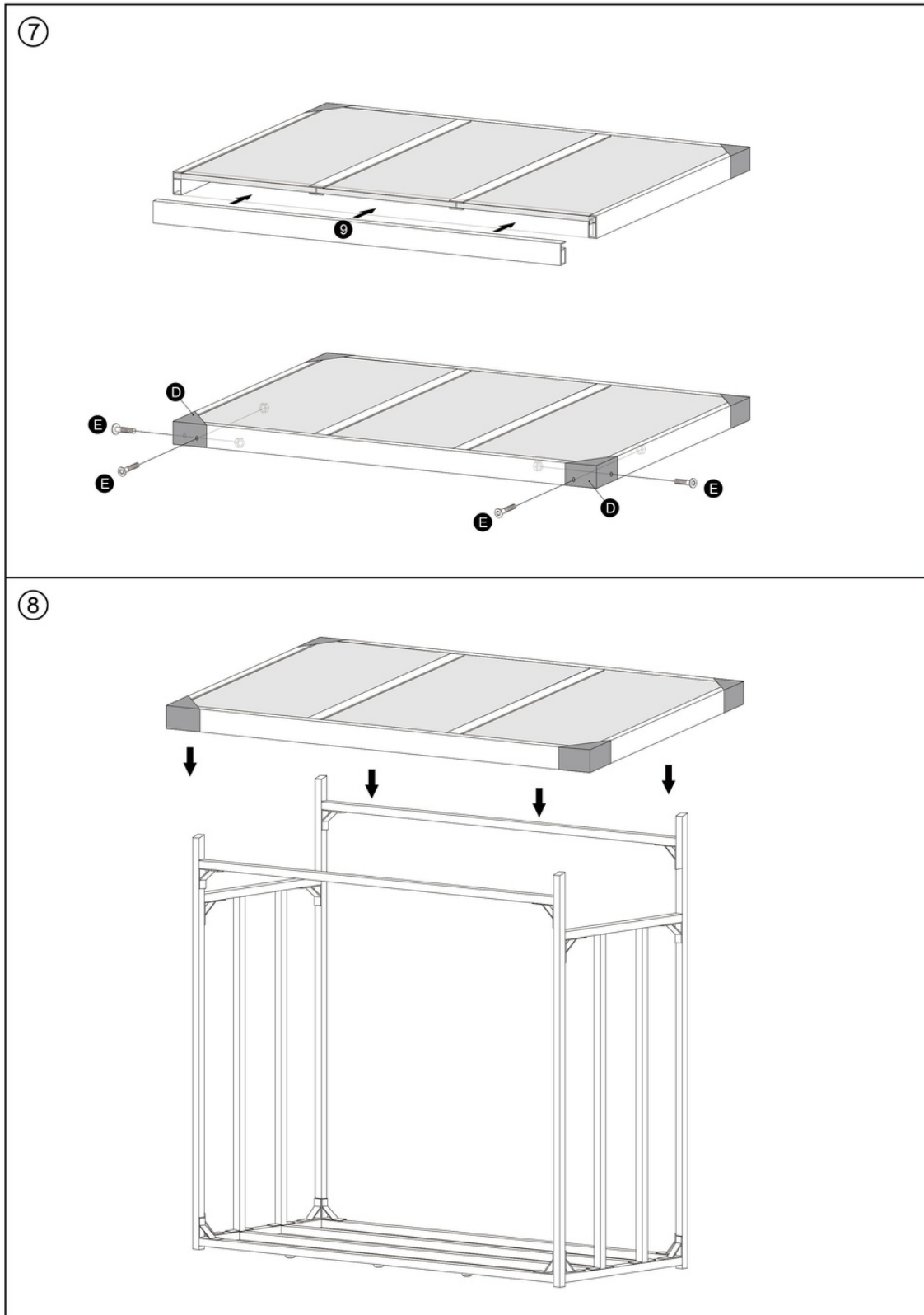

# Assembly Instruction

## Firewood Rack L H4H378.2

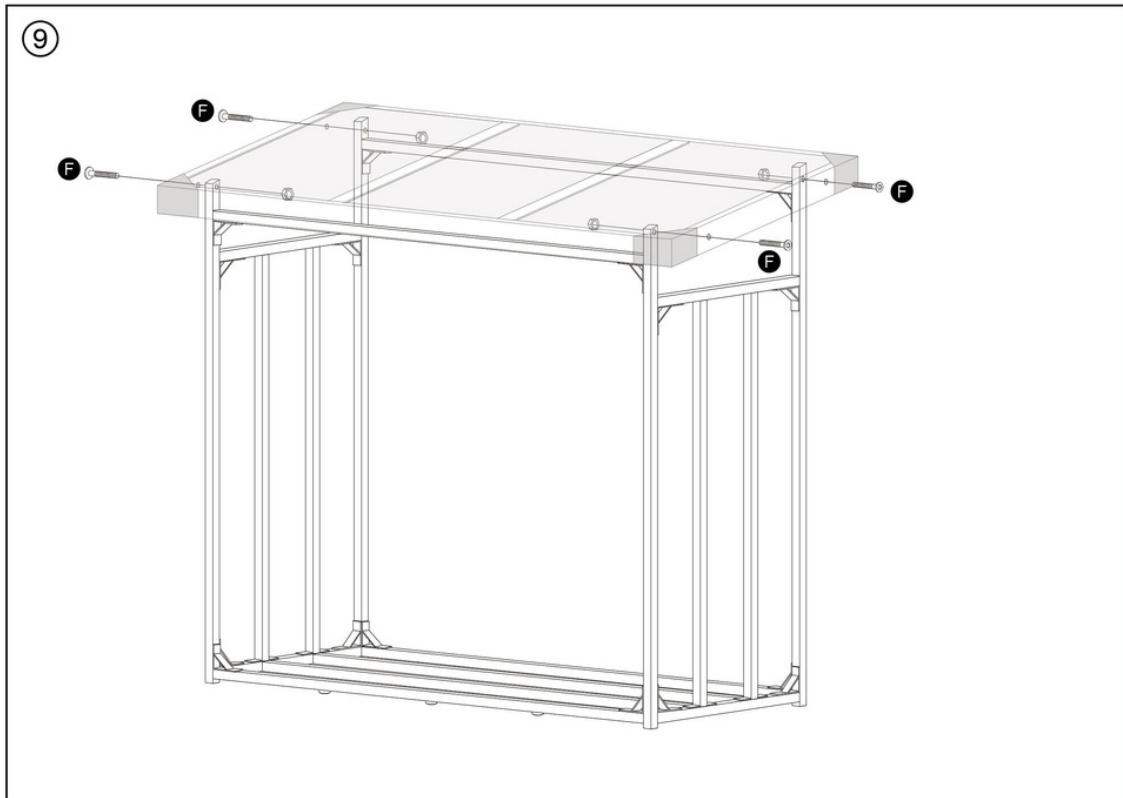







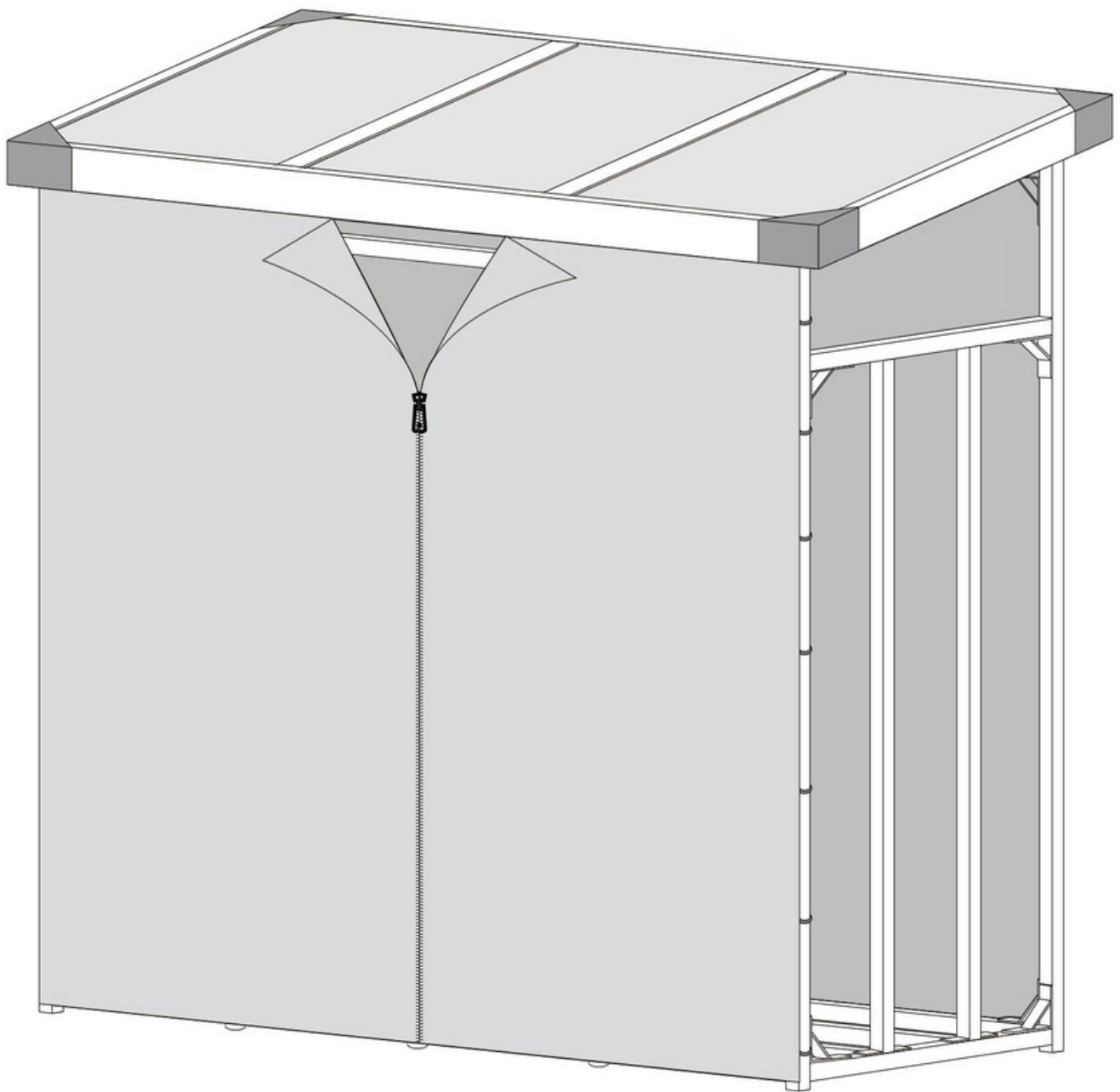







# Montageanleitung

Kaminholzregal XL H4H378.3













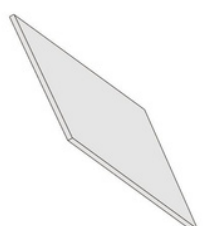

# Montageanleitung

## Kaminholzregal XL H4H378.3

Schrauben und Zubehör							
Nummer	Illustration	Maß	Stückzahl	Nummer	Illustration	Maß	Stückzahl
<b>A</b>		M8 × 40mm	× 16	<b>G</b>		Fuß	× 12
<b>B</b>		M8 × 35mm	× 76	<b>H</b>		M6 Innensechskant-Schlüssel	× 1
<b>C</b>		90° Verbindung	× 16	<b>I</b>		M8 Innensechskant-Schlüssel	× 1
<b>D</b>		Eckenverbindungsstück	× 4	<b>J</b>		M6 Schraubenschlüssel	× 1
<b>E</b>		M8 × 16mm	× 8	<b>K</b>		M8 Schraubenschlüssel	× 1
<b>F</b>		M6 × 45mm	× 4	<b>L</b>		Mutter	× 72

Stückliste								
Nummer	Stückart	Anzahl	Nummer	Stückart	Anzahl	Nummer	Stückart	Anzahl
<b>1</b>		× 2	<b>6</b>		× 2	<b>11</b>		× 2
<b>2</b>		× 2	<b>7</b>		× 2	<b>12</b>		× 2
<b>3</b>		× 4	<b>8</b>		× 2	<b>13</b>		× 1
<b>4</b>		× 2	<b>9</b>		× 2	<b>14</b>		× 1
<b>5</b>		× 2	<b>10</b>		× 2			

# Montageanleitung

Kaminholzregal XL H4H378.3

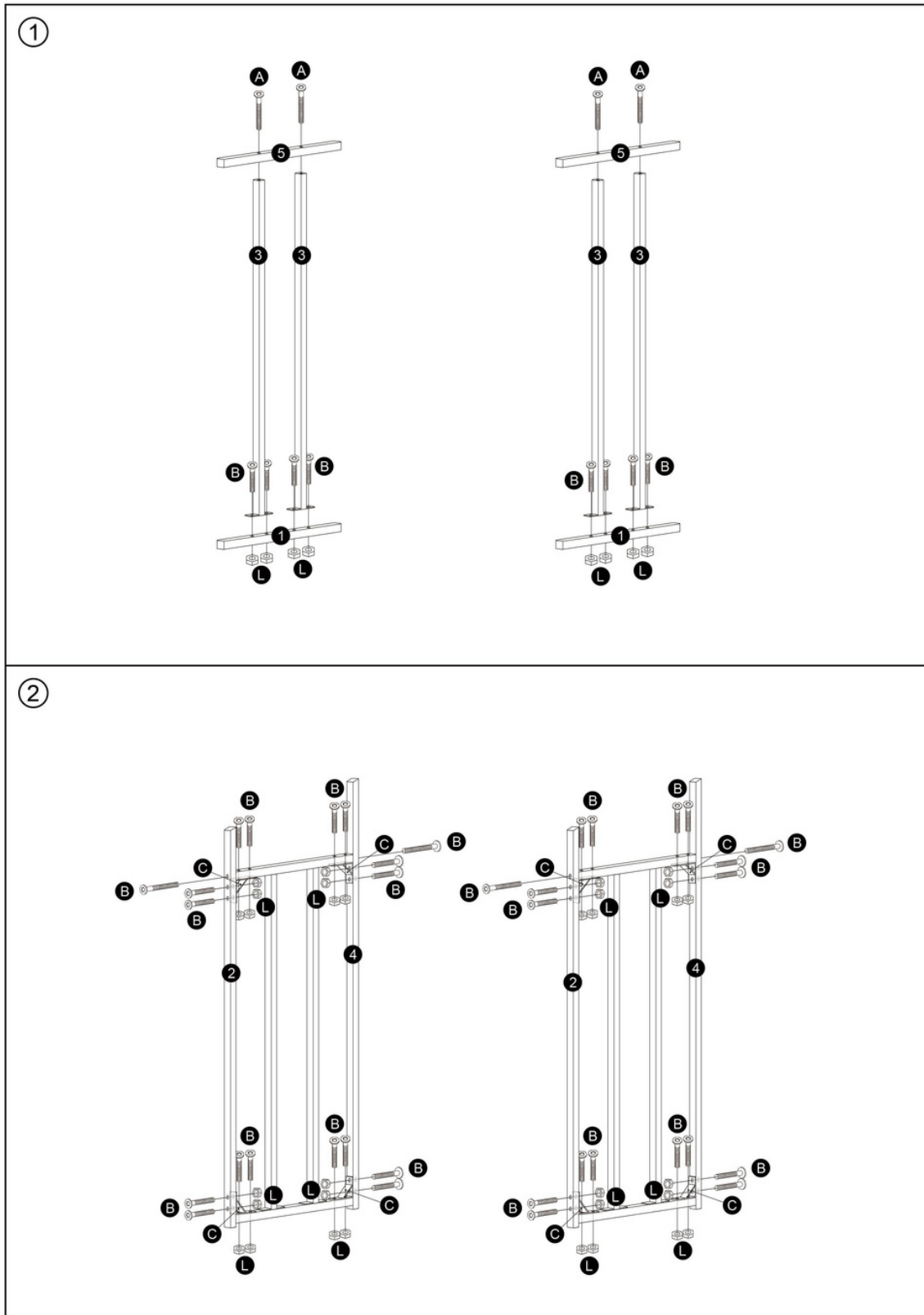

# Montageanleitung

Kaminholzregal XL H4H378.3

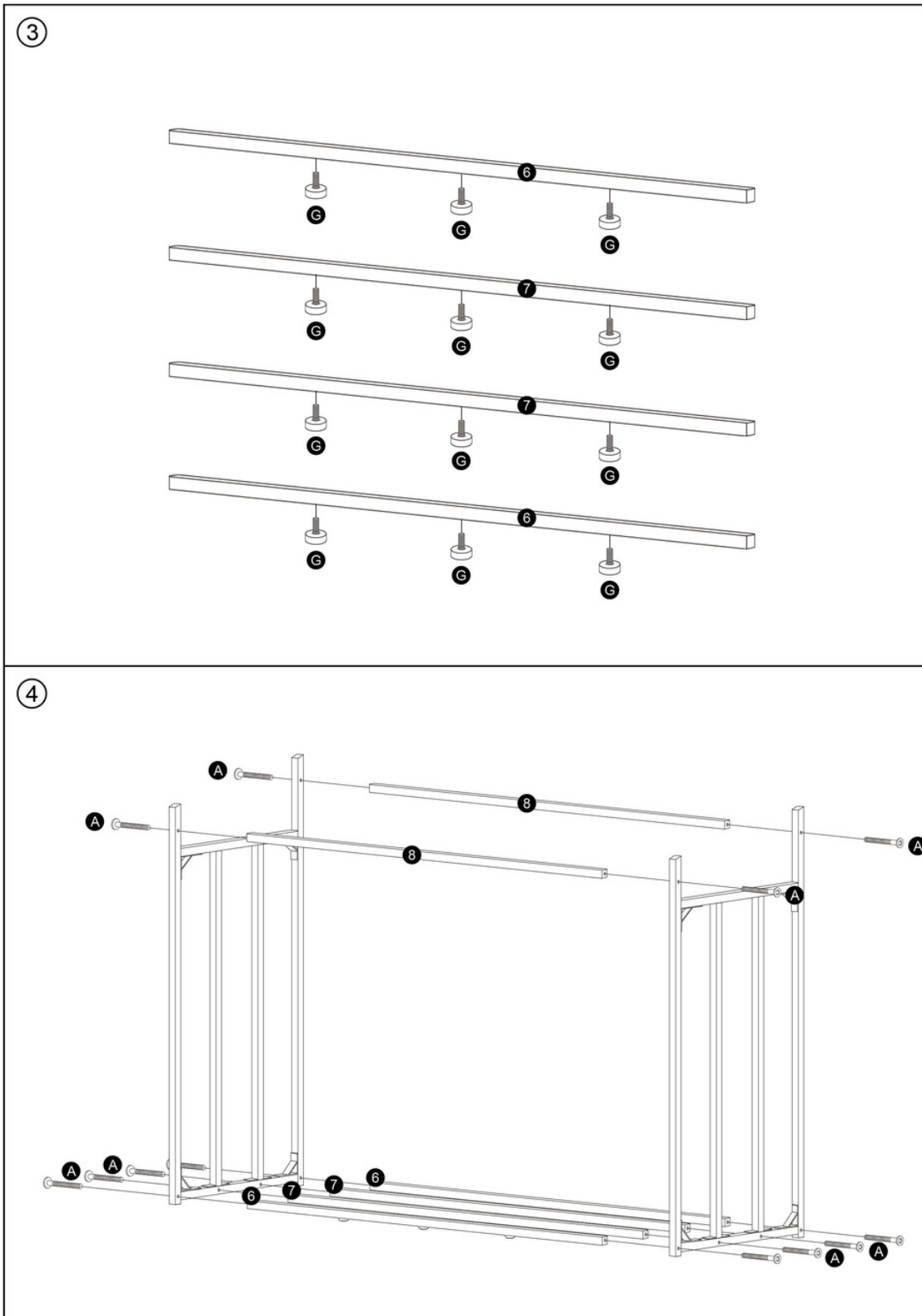

# Montageanleitung

## Kaminholzregal XL H4H378.3

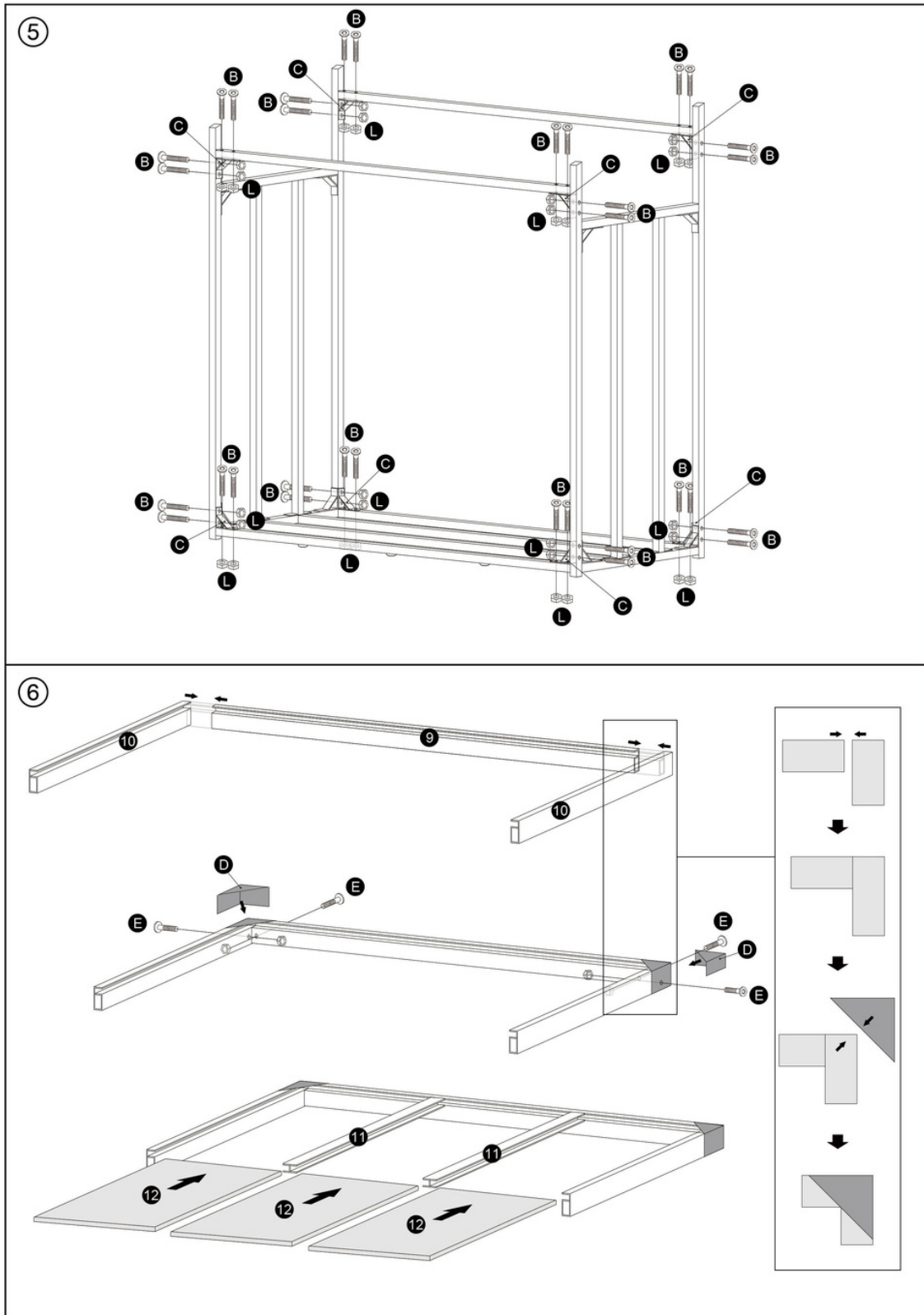

# Montageanleitung

Kaminholzregal XL H4H378.3

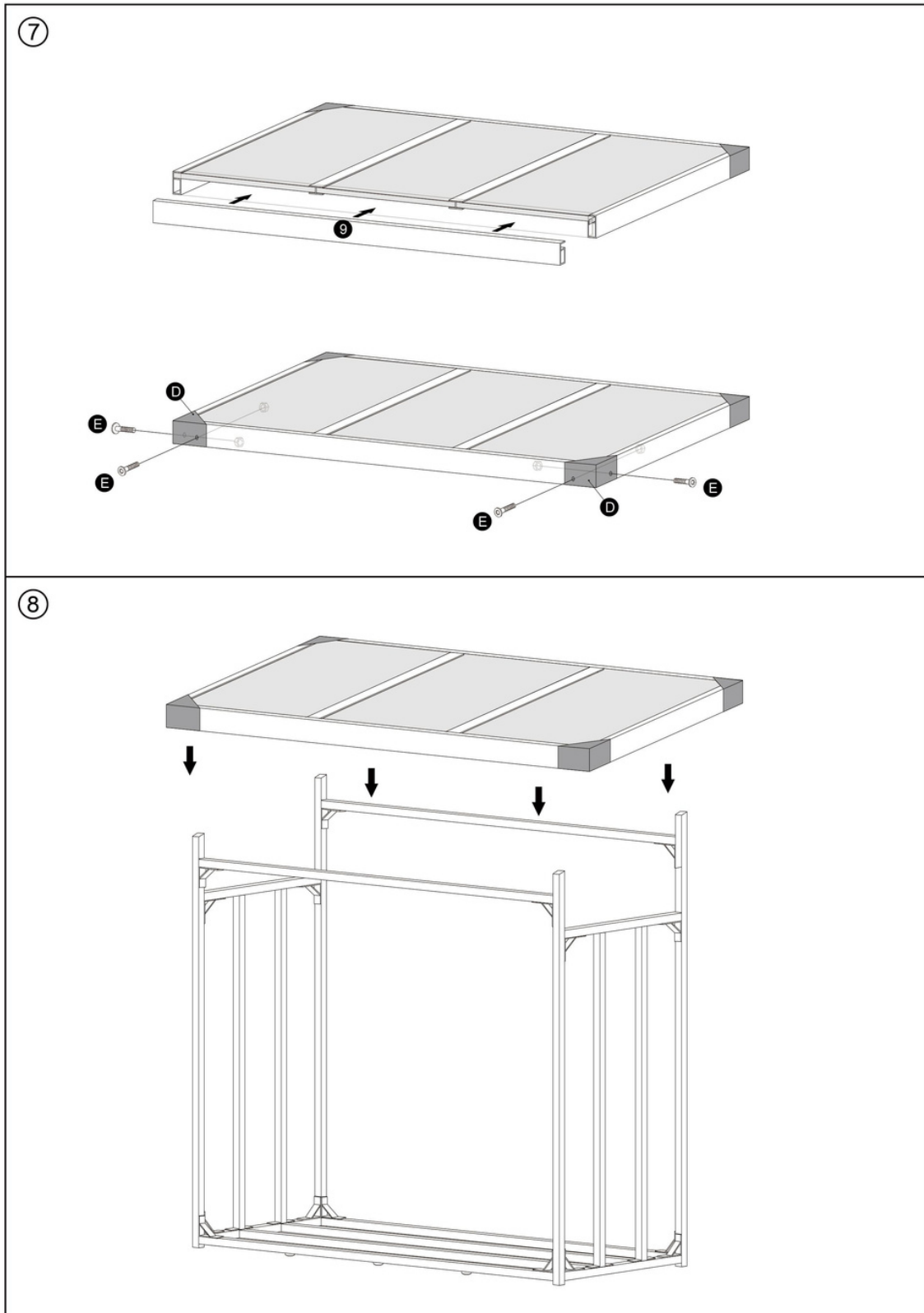

# Montageanleitung

## Kaminholzregal XL H4H378.3

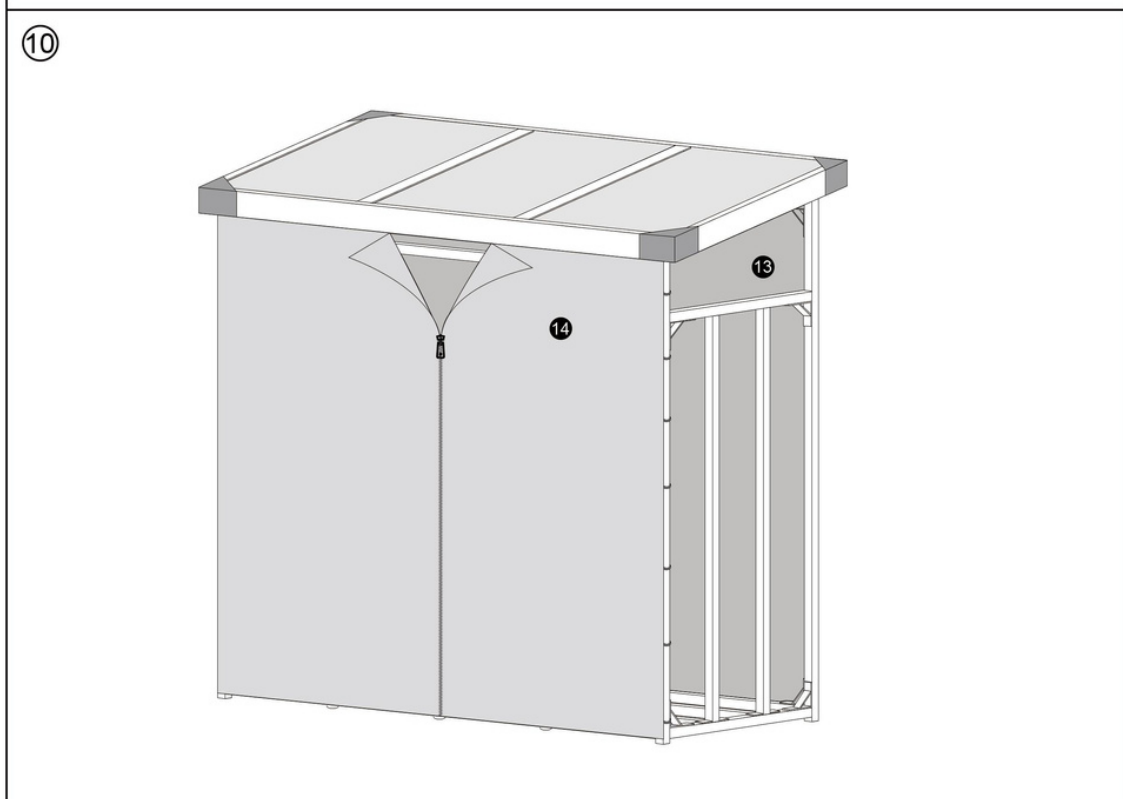
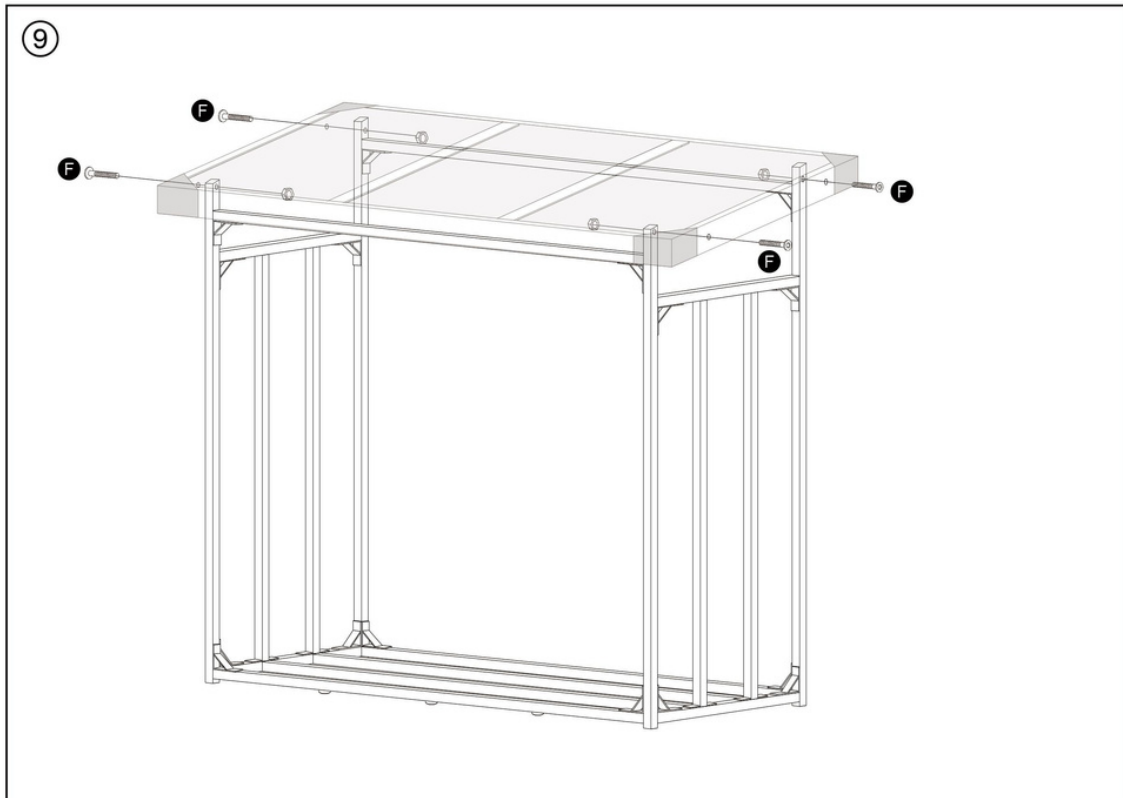

# Assembly Instruction



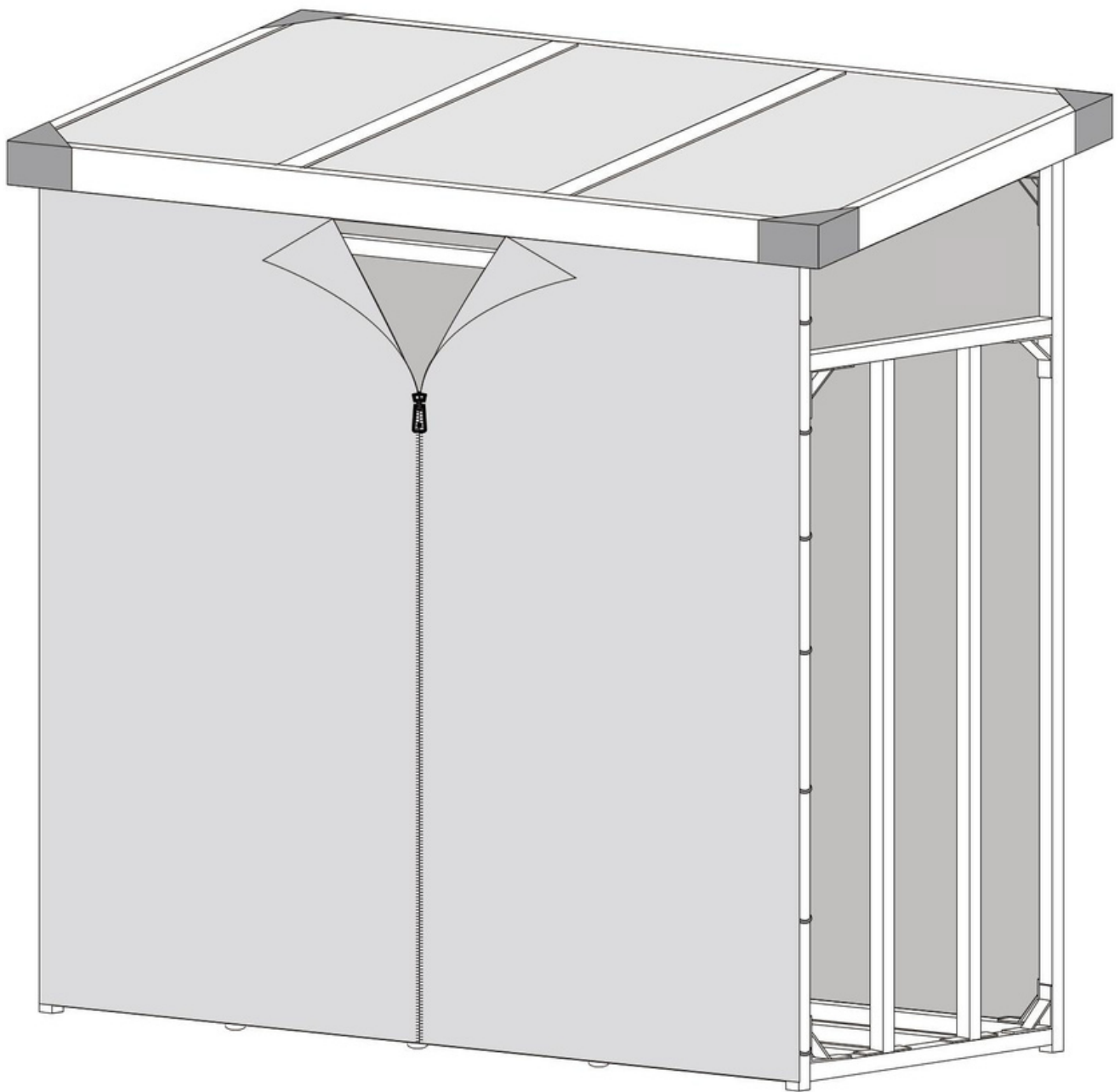









Firewood Rack XL H4H378.3















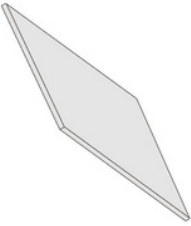

# Assembly Instruction

## Firewood Rack XL H4H378.3

Screws and Accessories							
Number	Illustration	Dimension	Piece	Number	Illustration	Dimension	Piece
<b>A</b>		M8 × 40mm	× 16	<b>G</b>		Foot pad	× 12
<b>B</b>		M8 × 35mm	× 76	<b>H</b>		M6-Allen wrench	× 1
<b>C</b>		90° connector	× 16	<b>I</b>		M8-Allen wrench	× 1
<b>D</b>		Corner fixer	× 4	<b>J</b>		M6-Wrench	× 1
<b>E</b>		M8 × 16mm	× 8	<b>K</b>		M8-Wrench	× 1
<b>F</b>		M6 × 45mm	× 4	<b>L</b>		Screw nut	× 72

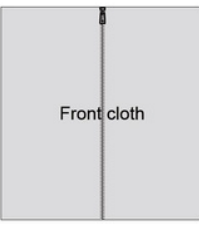
Parts List								
Number	Part art	Piece	Number	Part art	Piece	Number	Part art	Piece
<b>1</b>		× 2	<b>6</b>		× 2	<b>11</b>		× 2
<b>2</b>		× 2	<b>7</b>		× 2	<b>12</b>		× 2
<b>3</b>		× 4	<b>8</b>		× 2	<b>13</b>		× 1
<b>4</b>		× 2	<b>9</b>		× 2	<b>14</b>		× 1
<b>5</b>		× 2	<b>10</b>		× 2			

# Assembly Instruction

## Firewood Rack XL H4H378.3

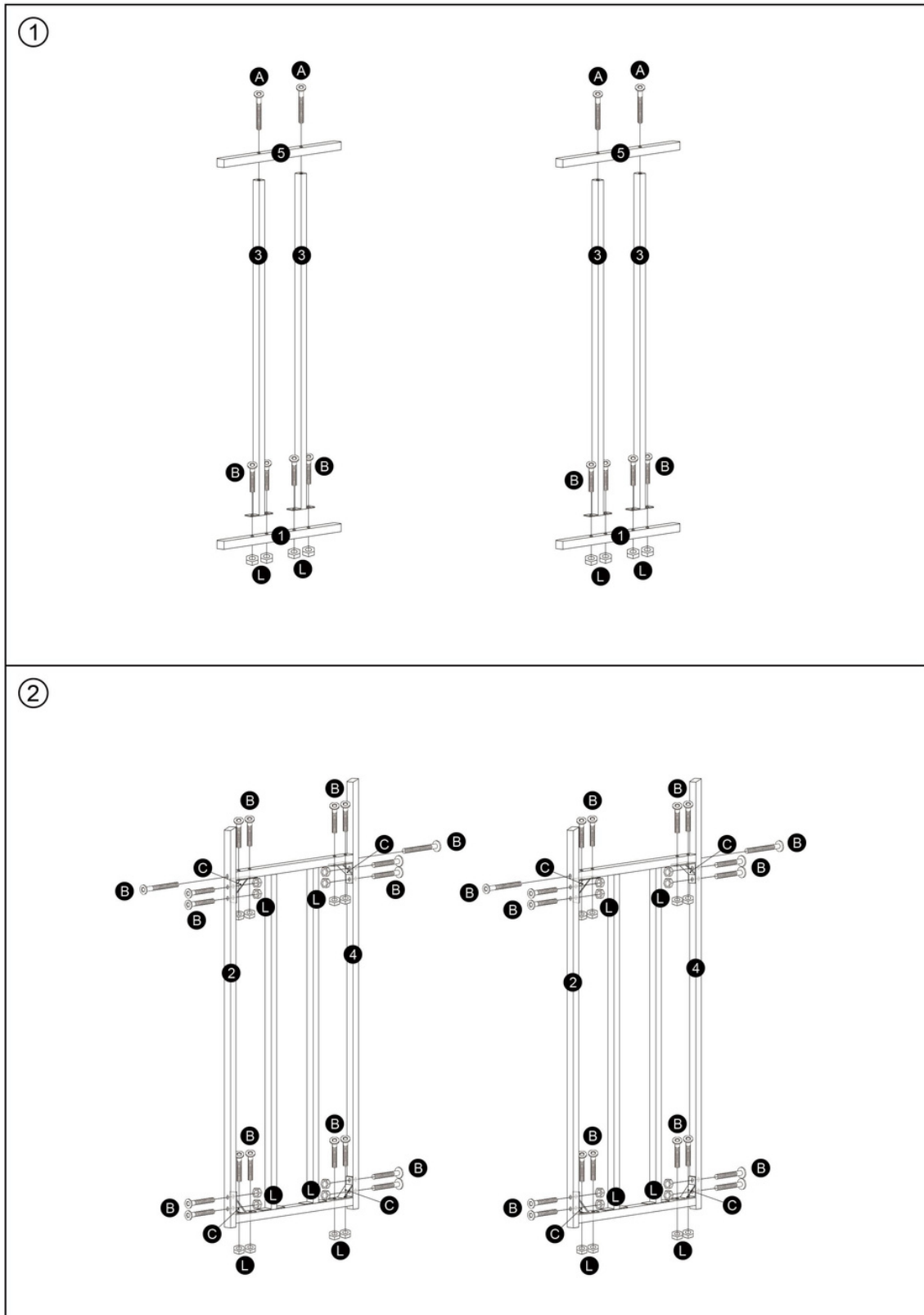

# Assembly Instruction

## Firewood Rack XL H4H378.3

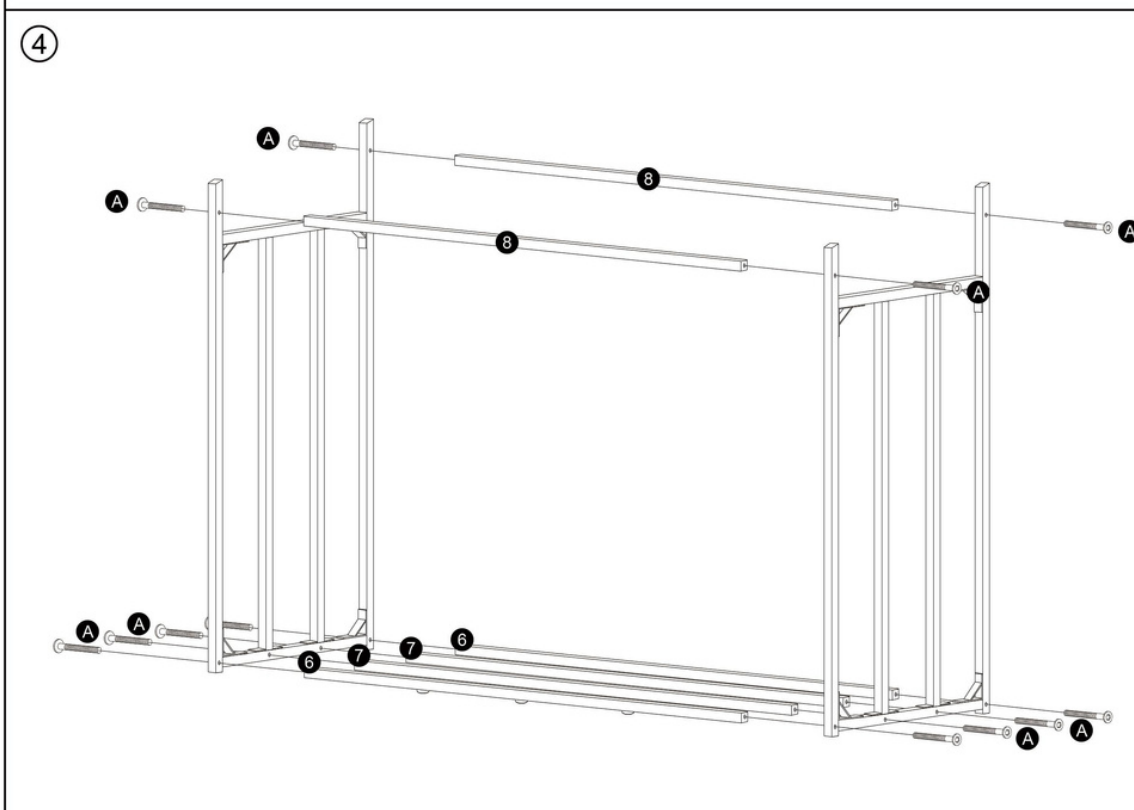
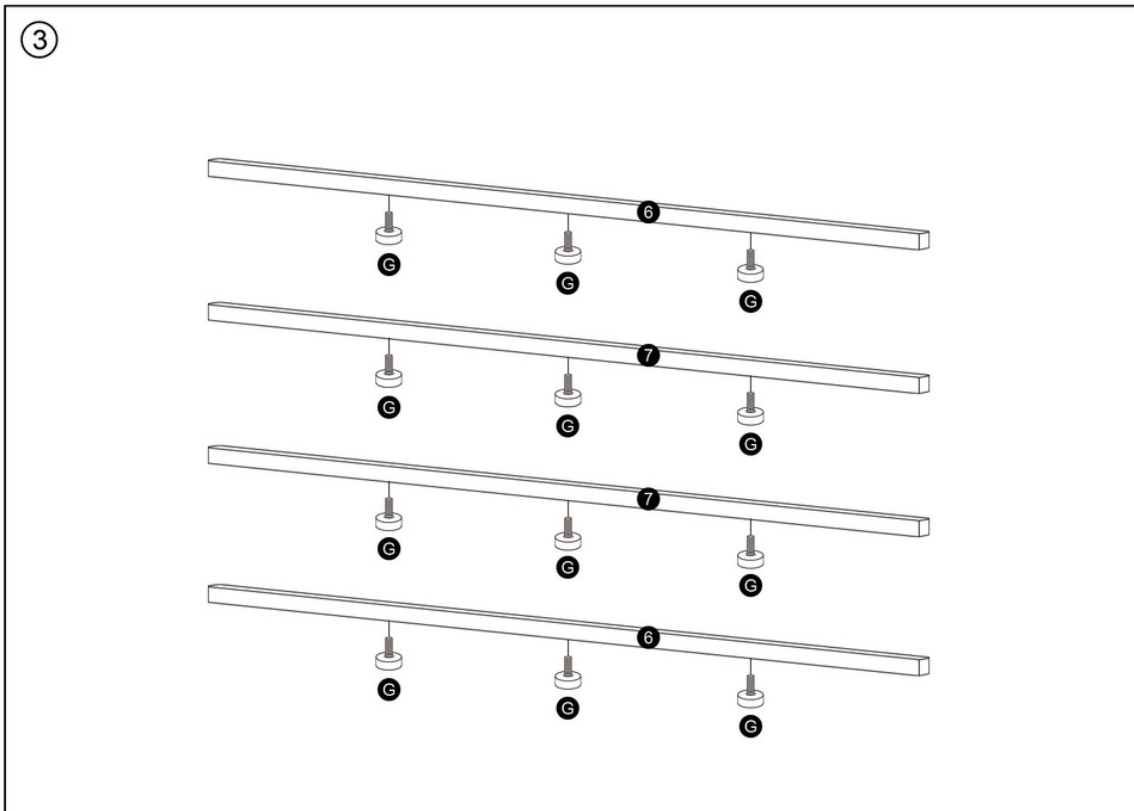

# Assembly Instruction

## Firewood Rack XL H4H378.3

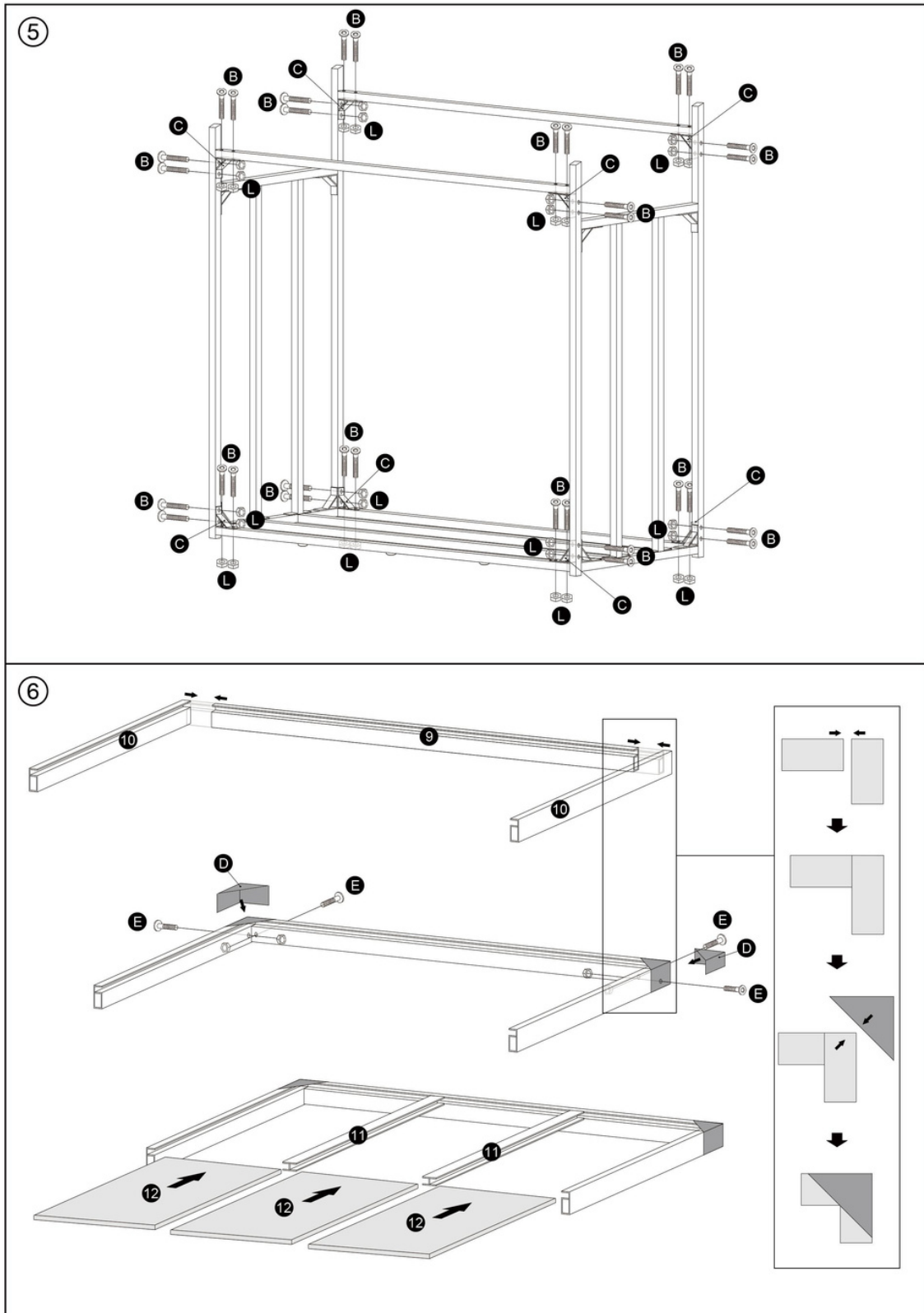

# Assembly Instruction

## Firewood Rack XL H4H378.3

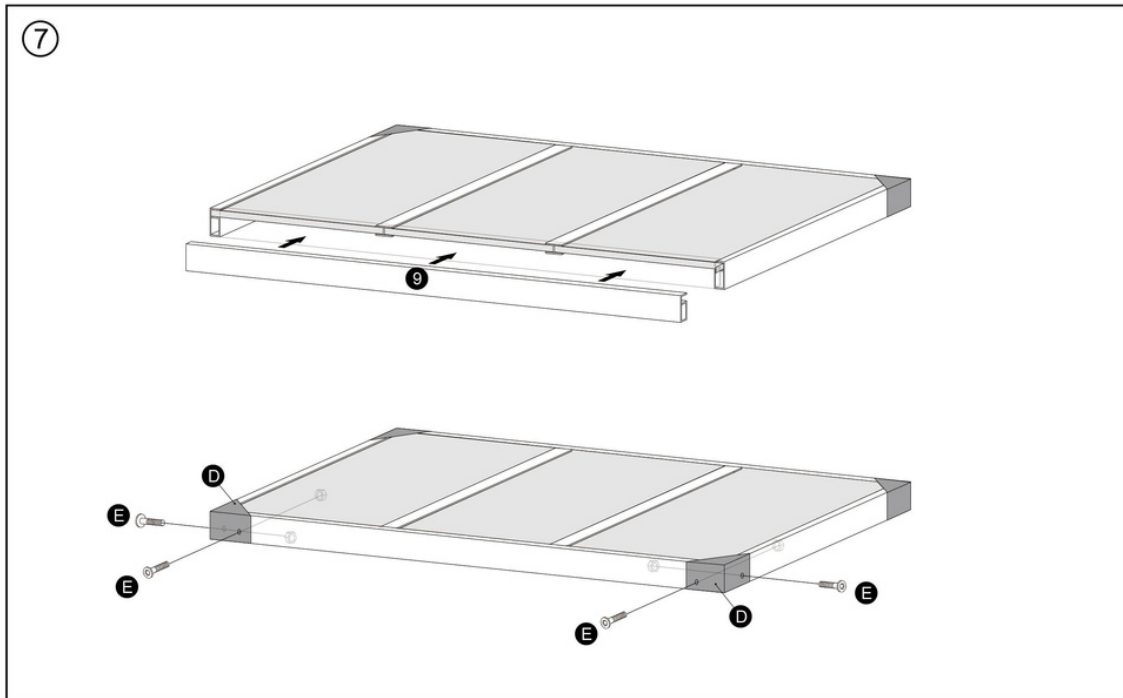

# Assembly Instruction

## Firewood Rack XL H4H378.3

